

SATURN
RESOURCE MANAGEMENT

Whole-Building Mechanical Ventilation

Whole-building ventilation is one of the most important issues in residential energy efficiency. The two major strategies for whole-building ventilation are: ventilating with air leakage and ventilation with a whole-building mechanical ventilation system. ASHRAE (American Society of Heating, Refrigerating, and Air Conditioning Engineers) publishes household ventilation standards. The current standard 62.2-2013 requires fan-powered ventilation in all homes with the exception of very leaky homes or homes that require little heating or cooling. If you air-seal homes during retrofit work, you are usually required to install whole-building mechanical ventilation or to add capacity to local ventilation in kitchens and bathrooms as needed.

The problem with using air leakage for ventilation is that the air leakage rate is usually either inadequate or excessive, and it is uncontrolled. Air leakage doesn't ventilate all areas of the building equally, leaving some areas drafty and fresh, and others stagnant and polluted. Also, air leakage is highest during severe weather, especially in winter, because it is driven by wind and temperature differences between indoors and outdoors.

The three types of whole-building ventilation systems are: exhaust, supply, and balanced. Exhaust ventilation pulls stale air out of the home with make-up air coming through air leaks. Supply ventilation pushes outdoor air into the home and moves stale air out through air leaks. Balanced ventilation uses one fan to bring fresh air in and another to exhaust stale air out.

The IRC requires exhaust fans in kitchens (100 cfm) and bathrooms (50 cfm). These fans are important for removing moisture and pollutants

at their source. Existing exhaust fans tend to be noisy and inefficient and aren't suitable for whole-building ventilation.

ASHRAE Ventilation Standard

Ventilation standards can be a confusing topic because of the lack of standardized terminology. The current ASHRAE Standard 62.2-2013 specifies ventilation fan size according to floor area and number of bedrooms. The standard describes how to size the ventilation system's fan using either the following formula or table to find the total ventilation rate (TVR).

$$TVR (CFM) = (0.03 \times \text{floor area}) + 7.5(\# \text{ bedrooms} + 1)$$

From ASHRAE Standard 62.2-2013

Floor Area (ft ²)	Number of Bedrooms				
	1	2	3	4	5
<500	30	38	45	53	60
501–1000	45	53	60	68	75
1001–1500	60	68	75	83	90
1501–2000	75	83	90	98	105
2001–2500	90	98	105	113	120
2501–3000	105	113	120	128	135
3001–3500	120	128	135	143	150
3501–4000	135	143	150	158	165
4001–4500	150	158	165	173	180
4501–5000	165	173	180	188	195

Fan flow in CFM. From ASHRAE Standard 62.2-2013, Table 4.1a

ASHRAE 62.2-2013 also requires 50 CFM local ventilation in bathrooms and 100 CFM in kitchens. An openable window contributes 20 CFM. If there is a deficit of local ventilation, add 25% of that CFM deficit to the whole-building ventilation fan's capacity to comply with the standard.

When a home is tested with a blower door, an infiltration credit may reduce the required ventilation rate. The procedure for qualifying for the infiltration credit is complicated and beyond the scope of this book. For a free online ASHRAE 62.2-2013 calculator, search for *Residential Energy Dynamics* on the internet.

Exhaust Ventilation

Exhaust ventilation systems use an exhaust fan to remove indoor air, which is replaced by infiltrating outdoor air. Better air distribution is achieved by using a remote fan that exhausts air from several rooms through small (about 3-inch) diameter ducts. In existing homes, install a high-quality ceiling exhaust fan, operating continuously. If you decide to replace a bathroom exhaust fan with an exhaust ventilation fan, the new fan should run continuously on low speed with a high speed to remove moisture and odors quickly. ASHRAE 62.2-2013 requires that new fans be no louder than 1.0 sone during continuous operation.

Exhaust ventilation systems are inexpensive and easy to install, but they don't recover heating and cooling energy or control the source of incoming air. Since most exhaust ventilation systems don't have filters, dust collects in the fan and ducts and must be cleaned out every year or so to preserve the design airflow. Exhaust ventilation systems create negative pressure, so they may not work for homes with fireplaces or other open-combustion appliances.

Exhaust systems create negative pressure within the home, drawing air in through leaks in the building shell. This keeps moist indoor air from traveling into building cavities, reducing the likelihood of moisture accumulation in cold climates.

In hot and humid climates, however, this depressurization can draw outdoor moisture into the home.

Central Exhaust Ventilator

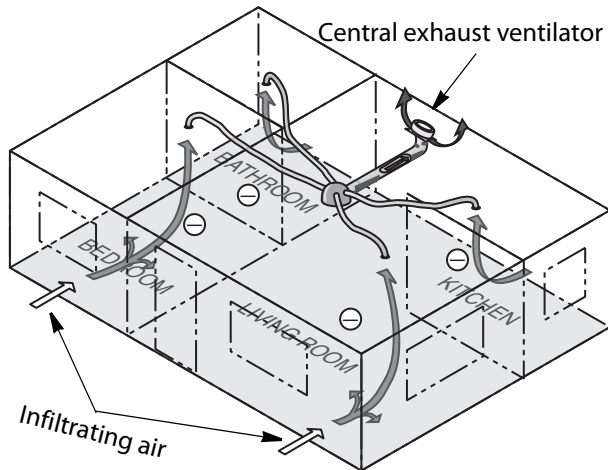

A central exhaust ventilator pulls air out of rooms and exhausts it outdoors. Make-up air infiltrates through air leaks in the building shell. The house is under a negative pressure. A central supply ventilator would be installed in a similar manner but with filtered outdoor air delivered to the home and stale air exiting through air leaks.

Supply Ventilation

Supply ventilation uses a fan to deliver outdoor air to the house, which becomes slightly pressurized, forcing indoor air out through air leaks. Using a supply fan makes it possible to filter incoming air, which is distributed to the bedrooms and living areas by ducts. A 5-to-10 inch diameter supply duct admits outdoor air to the air handler's return plenum. This supply duct often has a motorized damper that opens when the air handler blower operates, bringing outdoor air in, mixing it with return air, and then heating or cooling it.

Ventilation only happens when the air handler operates, so the air handler must operate even when heating and cooling aren't required. An electronic control can activate the blower, timing its cycles to deliver the design ventilation rate.

Using the air handler for ventilation is inefficient because forced-air blowers are designed to move around 10 times more air than needed for ventilation.

Supply Ventilation

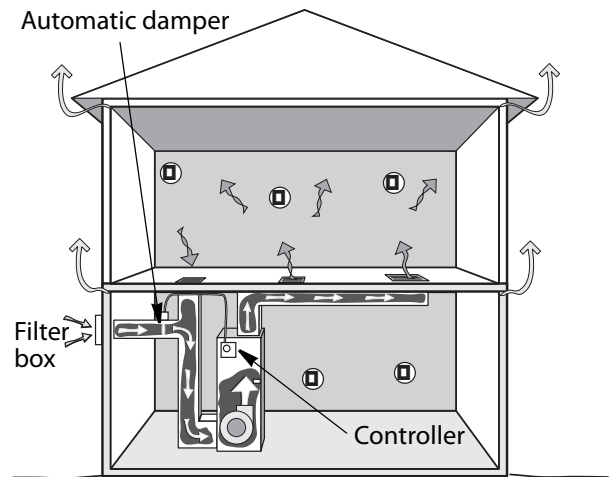

The air handler draws filtered outdoor air into the home, pressurizing it. Stale indoor air exits through air leaks in the building shell. The automatic damper opens when the air handler comes on. The controller opens and closes the damper and cycles the air handler as needed to ventilate the home.

Supply ventilation doesn't require a large air handler. You can use a correctly sized fan with its own small duct system, which operates continuously. Outdoor air is filtered, keeping most dust out of the duct system, which is an advantage of central supply ventilation over central exhaust ventilation.

Supply ventilation isn't appropriate for very cold climates because it pushes indoor air through exterior walls, where moisture can condense on cold surfaces.

Balanced Ventilation Systems

Balanced ventilation systems exhaust stale air and provide fresh air through a ducted distribution system. Of all the ventilation schemes, they do the best job of controlling pollutants in the home.

Balanced systems move equal amounts of air into and out of the home. Most balanced systems incorporate heat recovery ventilators (HRVs) or energy recovery ventilators (ERVs) that reclaim heat and/or moisture from the exhaust air stream.

Balanced systems, when operating properly, reduce many of the safety problems and moisture-induced building damage that is possible with unbalanced ventilation. They are not trouble-free, however, and there are many homes with “balanced” ventilation systems that experience pressure imbalances and poor air quality due to poor design, installation, or maintenance.

These complicated systems can improve the safety and comfort of home, but a high standard of care is needed to assure that they operate properly. Testing and commissioning is vital during both the initial installation and periodic service calls.

Heat and Energy Recovery Ventilators

The difference between an HRV and an ERV is that HRVs transfer heat only, while ERVs transfer both sensible and latent heat (moisture) between airstreams.

The HRV core is usually a *flat-plate* aluminum or polyethylene air-to-air heat exchanger in which the supply and exhaust airstreams pass one another with minimal mixing.

Heat travels through the core, by conduction, from the warmer to the cooler airstream. In heating climates, this means that heat contained in the exhaust air warms the incoming supply air. In cooling climates, the heat of the incoming fresh air is passed to the outgoing exhaust.

In cold weather, outgoing moisture condenses when it passes the cold incoming air in the HRV core. This condensate is drained. Defrost mechanisms are required in severe climates to thaw frozen condensate in the heat exchanger. The most economical defrost method is periodic recirculation of warm indoor air, though some HRVs with aluminum cores use electric heat strips.

Heat Recovery Ventilator

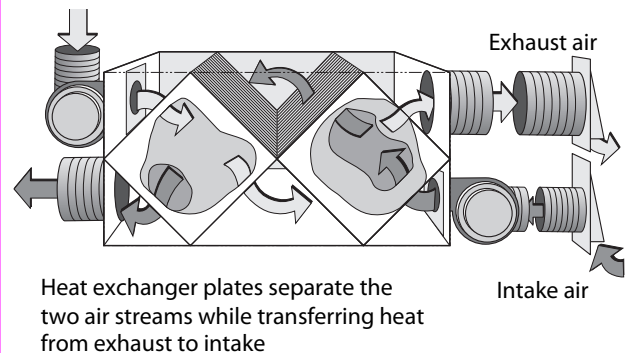

Exhaust air moves through the heat exchanger, heating its plastic or metal plates. The warm metal or plastic heats the incoming air, which moves in alternating spaces between plates, and in the opposite direction as the exhaust air.

Energy Recovery Ventilator

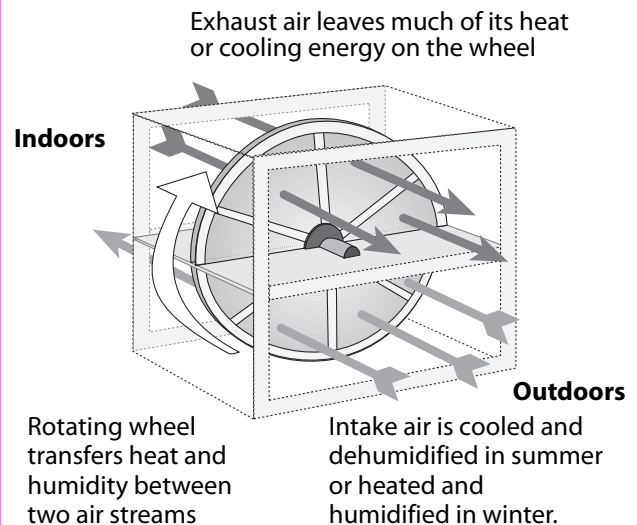

An ERV transfers heat and humidity between airstreams, recovering heat during winter and recovering cooling energy during summer.

ERVs can also be used to ventilate homes during summer in warm climates, where they limit the intake of outdoor humidity. ERVs reduce the costs of conditioning ventilation air, and the greater the difference in temperature and moisture between the air streams, the more energy is

recovered. Energy recovery ventilators may improve comfort in winter by transferring moisture as well as heat to cold dry incoming air.

Ventilation-air distribution — Whole-building ventilators are most effective when installed with their own system of supply and return air ducts. Fully ducted systems are popular for buildings with hydronic heating, or for very energy-efficient homes heated by just a few space heaters.

Homes with central forced-air systems often have the ventilator connected to the central duct system. The supply ventilation air comes from outdoors through the ventilator and into a main return duct 4 to 8 feet from the air handler. In a simplified installation, both the supply and exhaust of the ventilator may be connected to the air handler's return ducts. The ventilator's exhaust duct should be connected closer to the air handler and the ventilator's supply duct farther away.

When balanced ventilators use forced-air ducts for distribution, the ducts should be very airtight. The air handler's blower should run at its lowest speed when the ventilator is running to help distribute the air. Running the blower also increases energy use. New electronically commutated blowers, operating at 250 watts or less, make the extended and simplified ventilator installations more practical and energy efficient. Some ventilators connect to forced-air ducts but don't use the air handler's blower, but this strategy results in airflow that is too low to provide adequate ventilation.

Like forced-air heating and cooling systems, many whole-building ventilation systems are installed without measuring system airflow or room airflows. Lack of testing leaves many systems performing inadequately. At minimum, installers should measure supply and exhaust airflow to ensure that they achieve the designed airflow and are balanced with one another.

Humidistats or timers are used with manual switches to control the operation of air-to-air heat exchangers for insuring good air quality. The

associated system of ducts is subject to the same problems of leakage, obstruction, and balancing as other forced-air distribution systems.

See "Ventilation and Air Leakage" on page 83.

Typical Ventilator Ducting

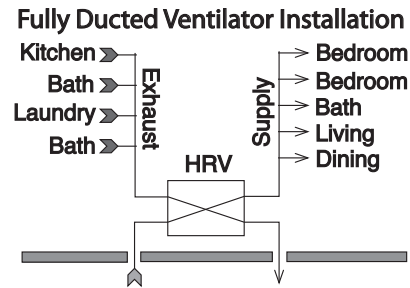

For airtight superinsulated homes in cool regions this system is very common. Heat may be supplied by central or space heat.

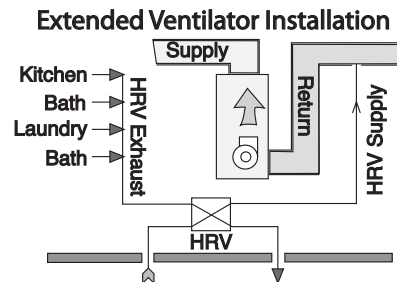

The ducted exhaust installation requires the air handler's blower to draw supply air into the home.

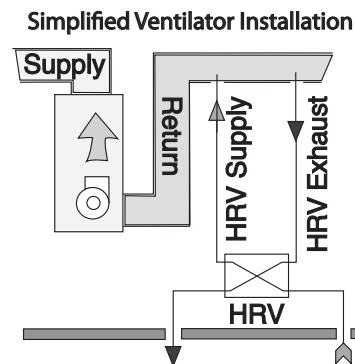

Least satisfactory of the three options, the simplified installation depends on proper duct sizing and air-handler airflow.