



SATURN
RESOURCE MANAGEMENT

Energy Auditor Overview Training Handbook

CONTENTS

Building Science and Energy Auditing

ANALYZING ENERGY CONSUMPTION.....	4
-----------------------------------	---

Baseload Energy Usage

REDUCING WATER-HEATING COSTS	6
------------------------------------	---

USING APPLIANCES EFFICIENTLY.....	8
-----------------------------------	---

IMPROVING LIGHTING EFFICIENCY.....	11
------------------------------------	----

Heating and Cooling Systems

EVALUATING HEATING SYSTEMS.....	12
---------------------------------	----

EVALUATING COOLING SYSTEMS.....	15
---------------------------------	----

THERMOSTATS	20
-------------------	----

PASSIVE COOLING MEASURES.....	22
-------------------------------	----

Building Shell

EVALUATING INSULATION	24
-----------------------------	----

SEALING AIR LEAKS	28
-------------------------	----

EVALUATING WINDOWS.....	30
-------------------------	----

EVALUATING MOISTURE IN HOMES.....	34
-----------------------------------	----

FINDING MORE INFORMATION.....	35
-------------------------------	----

BUILDING SCIENCE AND ENERGY AUDITING

Your job is to perform brief energy audits on the homes of your customers. Energy auditing requires a knowledge of the following.

- How homes use and waste energy
- Energy conservation measures: building retrofits and customer choices
- Building science: how the home operates as a system

The audit you perform is called a Tier 1 energy audit. This audit accomplishes some or all of the following tasks.

- Install simple effective energy conservation measures, such as compact fluorescent lights and water-saving shower heads.
- Collect information about insulation levels, type of heating system, and solar orientation.
- Educate the customer about behavioral choices that can save energy.
- Ask questions and discuss the home's particular energy issues.

Customer Observations of Home Performance

Asking the customer questions about their home's energy consumption and performance facilitates a discussion about the home's and the customer's particular energy issues. This help guide efforts to save energy and improve comfort. Here are some example questions that can be useful.

- Which rooms are the least comfortable during cold weather? Do you notice drafts? During the coldest days, how long does your heating system run?
- Which rooms are the least comfortable during the hot weather? During the hottest days, how long does your cooling system run?
- Do you ever notice the odor of mold or mildew? In which rooms? During what season?

- Do you ever notice odors near your heating or cooling equipment? Does your heating or cooling equipment ever make unusual noises?
- Does condensation ever build up on your windows? During what time of year? How long does it persist?
- When was the last time your heating or cooling system was serviced? What type of work was performed?

Typical Energy Consumption in Colorado

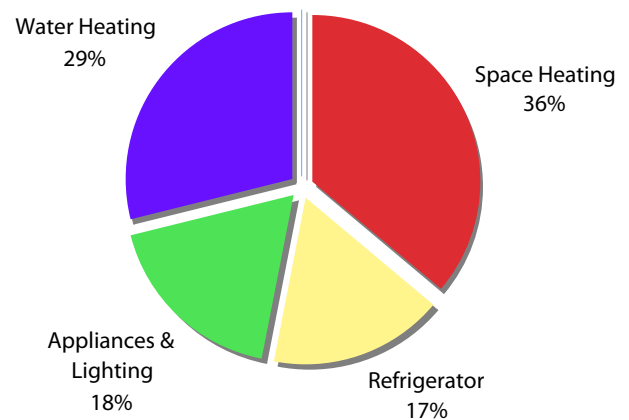

Percentage of total utility cost in dollars, for U.S. households, from the Energy Information Administration.

The consumption of energy in most households is concentrated among heating, air conditioning, water heating, lighting, and refrigeration.

ANALYZING ENERGY CONSUMPTION

You'll find it useful to analyze how energy is used in your customer's home so you can focus your home improvement advice on the best energy-saving measures. Utility bills are the best summary of a home's performance. Ask the customer for as many recent bills as they can find for this analysis – a year's worth is ideal. If the customer receives separate gas and electric bills, include them both in your analysis.

Energy bills include two types of energy consumption: baseload consumption and seasonal consumption. Baseload consumption consists of year-round energy uses, such as water heating, refrigeration, and lighting. These don't change much from month to month. Seasonal consumption, on the other hand, consists of heating in the winter and cooling in the summer. This seasonal consumption varies depending on the weather, the home's insulation and air-tightness, and the customer's thermostat management.

Customers can reduce their baseload consumption by installing a water heater blanket or installing compact fluorescent lamps. Customers reduce their seasonal energy consumption by improving their home's insulation or by servicing their heating and cooling systems.

- Natural gas is measured in therms or decatherms (dkt). A therm is about one-hundred cubic feet of natural gas. A decatherm is ten therms, or one-thousand cubic feet of natural gas.
- Electricity is measured in kilowatt-hours (kWh). One kilowatt-hour is the amount of electricity consumed by a 100-watt bulb in 10 hours.

How to Separate Baseload and Seasonal Energy Consumption

You can calculate baseload consumption by looking at a utility bill for a month in the spring or fall when the customer used little or no heating or

cooling. That month's total bill should be the smallest electric or gas consumption of the year and is composed almost entirely of baseload uses. If the customer uses both gas and electricity, include them both in the estimation of monthly baseload. If you multiply this lowest monthly baseload gas or electric usage by twelve (the number of months in a year), you'll have a rough estimate of the customer's total annual baseload electricity and gas usage. Once you've estimated how much of the annual utility cost is baseload uses, subtract the annual gas or electric baseload from the total annual gas or electric consumption to calculate the annual heating or cooling consumption.

Look at a monthly utility bill (or bills, if you have separate gas and electric bills for a customer), and subtract the monthly baseload usage from the total usage. The amount left over is the amount used for heating or cooling that month. Heating energy consumption is highest during the cold months of winter, and cooling consumption is highest during the hot months of summer.

Analyzing Utility Bills

Home without air conditioning



BASELOAD ENERGY USAGE

REDUCING WATER-HEATING COSTS

Water heating is a baseload use, therefore its cost doesn't vary much from month to month. In moderate climates, many families spend as much money on water heating as they spend on space heating or air conditioning annually.

Customers can reduce water heating costs through several different approaches.

- Reducing the temperature setting at their water heater to reduce standby loss.
- Reducing the standby heat loss from their water heater's tank and nearby piping
- Reducing the amount of hot water used.
- Replacing the water heater with a more efficient model.

Adjusting Water Heater Thermostats

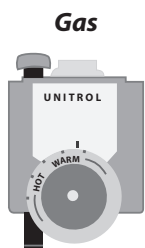

Gas water heater thermostat controls show only "warm" and "hot" temperatures. Adjust the knob until the tap water temperature measures 120 degrees F.

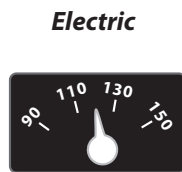

Electric water heaters have two thermostats hidden under covers on the front of the tank. Turn the power off at the electrical panel, remove the covers, and set both thermostat dials to 120 degrees F.

Customers can reduce their water heater's standby losses by adjusting its thermostat to a lower temperature.

Building Science Temperature Stratification

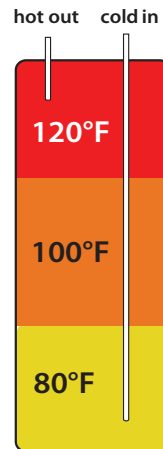

Fluids, like air and water, stratify in layers according to temperature. The hottest fluid rises to the top and the coolest falls to the bottom. Temperature stratification in a water heaters allows us to harvest the hottest water off the top. Cold water is added to the bottom, which encourage this beneficial stratification.

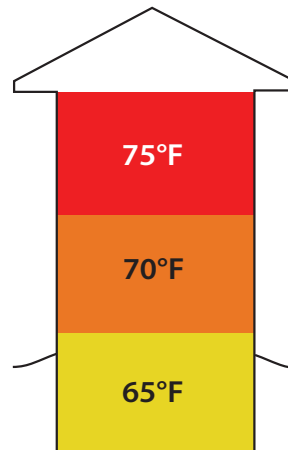

Temperature stratification isn't beneficial to a home's occupants, who experience discomfort from temperature variations. The degree of stratification depends on the temperature of the furnace's supply air, the degree of air mixing, and the height of the building.

Water Heater Tank Improvements

The most basic conservation measure for water-heating is to reduce hot-water temperature. Customers can adjust water heater's thermostat. Measure water temperature with a thermometer at the tap closest to the water heater. Suggest to the customer to adjust the thermostat so that tap water is no hotter than 120 degrees F. This is hot enough for most household uses.

Installing a water-heater blanket with at least an R-12 insulation level is a cost-effective energy measure, unless a customer plans to replace the existing storage water heater with a more efficient model. (See “Evaluating Insulation” on page 24 for definition of R-values.) Water heaters that are more than 10 years old usually have only one inch of fiberglass insulation for a total of R-3. Water-heater insulation blankets are available in many hardware and department stores and are easy to install.

Safety is the primary consideration when installing the blanket. Follow the manufacturer’s printed instructions packaged with the blanket.

Customers can also reduce heat loss at the hot-water pipes by installing foam pipe insulation on the first five feet of both the hot and cold water lines. This reduces the standby heat loss that takes place when hot water circulates by convection up into the supply piping. For an added savings, customers can insulate all their the hot water pipes to reduce hot-water cooling as water travels to the fixtures.

Reducing Hot Water Consumption

Showering is typically the biggest hot-water use in the home. You can measure shower volume by calculating the time it takes to fill a one-gallon plastic milk jug from the shower spigot. Cut the top off to fit it over the shower head. If the jug fills in less than 12 seconds, the customer’s flow rate is more than 2½ gallons per minute. If this is the case, install a water-saving shower head rated for a flow of 1½ gallons per minute. **Installing a water-saving shower head is a job that you the auditor can accomplish.**

A majority of energy used by dishwashers and washing machines is consumed by the water heater to produce hot water. New dishwashers and washing machines use far less water and energy than their predecessors. Front-loading washing machines, for example, save up to half the water and energy of top-loading machines.

Hot water leaks are also a serious energy waster. Advise customer to repair any leaky faucets in their homes.

Water Heater Replacement

Some older water heaters have only an inch of fiberglass insulation (about R-3) installed between the inner tank and outer shell. However, many new gas water heaters have 2 inches of foam insulation (R-12 or more), and better electric models have 3 inches of foam (R-18 or more). More insulation helps reduce the heat loss through the walls of the tank.

Installing Water Heater Blankets

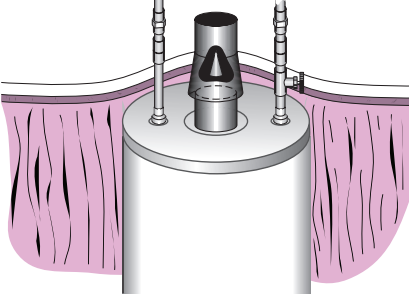

Gas water heater
Do not insulate the top of gas water heaters.

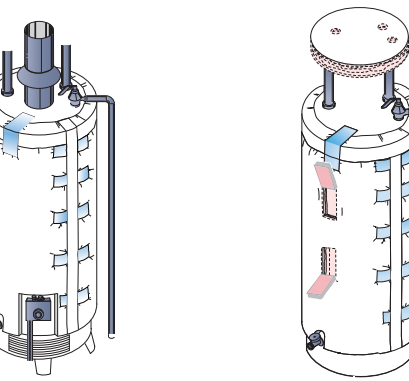

Electric water heater
Insulate the top of electric water heaters.

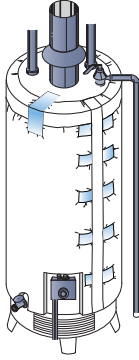

Keep insulation away from a gas water heater’s gas valve and burner door.

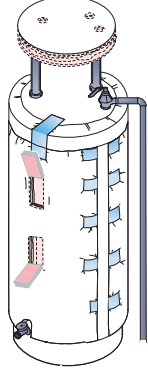

Cut out small rectangles over the elements and controls of electric water heaters.

Water heater blankets slow heat loss through the walls of the tank. This continuous heat loss accounts for 15 to 40 percent of the hot water energy cost.

Advise your customers to ask for these higher insulation levels when they buy new water heaters. This R-value information is found on the specification label attached to the water heater and on the Energy Guide label.

Recommendation for Customers Reducing Water Heating Costs

- ✓ Measure your hot water temperature, and adjust your water heater thermostat down to about 120 degrees F.
- ✓ Insulate your water heater and the water pipes near the water heater.
- ✓ Repair all faucet leaks.
- ✓ Install a low-flow shower head if your existing one uses more than 3 gallons per minute.

USING APPLIANCES EFFICIENTLY

The electricity consumed by appliances accounts for up to one third of the energy consumption in many homes. Customers can reduce their use of electricity for appliances by either using their existing appliances more efficiently, or by purchasing more efficient appliances.

Refrigerators and Freezers

New refrigerators consume as little as one-third the energy of models that are more than 10 years old. Replacing an older inefficient refrigerator with a model that uses less than 500 kilowatt-hours (kWh) per year reduces a customer's electricity costs significantly.

Offer customers these operating tips to save energy and money on refrigeration. Help the customer test temperatures and activate the Energy Saver switch if appropriate.

- Use a thermometer to measure refrigerator and freezer temperature. Adjust the dials inside the refrigerator and freezer as needed until the ther-

mometer reads 35 to 40 degrees F for the refrigerator and 0 to degrees 5 F for the freezer.

- Activate the Energy Saver switch, which turns off the anti-sweat heaters around the refrigerator door. These heaters aren't usually needed, unless the home is so humid that condensation or frost forms on the door seals.
- To limit door openings, decide exactly what you want before opening the refrigerator or freezer door. Try to remove all the items you need at once, and do the same when replacing them.

Suggest the following when a customer plans to buy a new refrigerator or freezer.

- Prefer refrigerators with an upper freezer compartment. Side-by-side refrigerator/freezers tend to use more energy.
- Prefer a chest freezer instead of an upright model, because chest freezers use less energy.
- Don't operate a second refrigerator. Make do with one large energy-efficient model.

City landfills and other disposal facilities are required to recycle refrigerators in a way that prevents the refrigerant from escaping into the atmosphere, where it could damage the ozone layer.

Setting Refrigerator and Freezer Controls

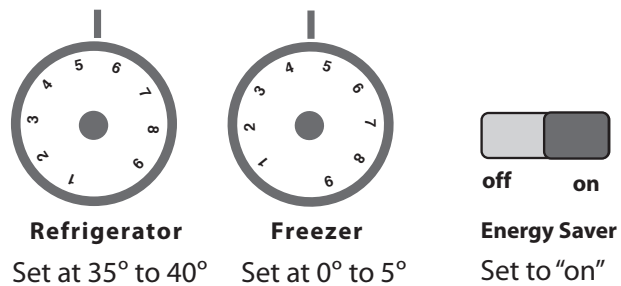

Customers can save money right away by making these simple adjustments to refrigerators and freezers.

ENERGY STAR® and Energy Guide Labels

Advise customers to look for the ENERGY STAR label whenever they shop for appliances.



Wow! This new refrigerator only uses 440 kilowatt-hours annually, for an average cost of \$37.

Older refrigerators use 1000 to 1500 kilowatt-hours annually.

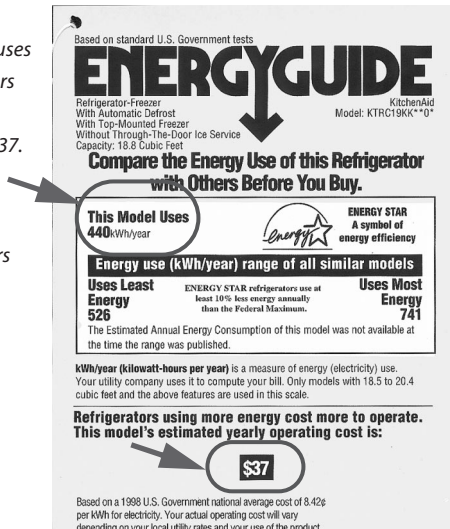

The Energy Guide labels is posted on all major appliances before they are sold. They help customers compare the annual energy use of the labeled model to its competitors.

Electric Cost of Appliances

Appliance	Usage, kWh per year	Annual Cost
Ten-year-old refrigerator or freezer	900-1800	\$90-\$180
New ENERGY STAR refrigerator or freezer	450-550	\$45-\$55
Hot tub / spa	2300	\$230
Water bed	1000	\$100
Television	100-1000	\$10-\$100
Well pump	500	\$50
Furnace fan (air handler)	500	\$50
Computer	50-400	\$5-\$40
Humidifier	50-1500	\$45-\$150
Engine heater	100-400	\$10-\$40

Data from Lawrence Berkeley Laboratory and others. Based on electric costs of 10¢ per kilowatt-hour.

Laundry Savings

Front-loading washing machines use far less energy and water than top-loading machines. According to recent field tests, a front-loading machine will use up to 60% less energy, 40% less water, and 20% less detergent than with a top-loading machine.

Front-loading washers cost between 50 and 100 percent more than conventional top-loading models but will repay the initial investment in 2 to 5 years, if the customer currently use warm or hot water for clothes washing. Front loaders will cut water usage and cost in addition to their energy savings.

The faster spinning front-loading washer also gets the clothes far drier than a top-loading washer. This saves approximately 20 percent of the energy needed for clothes drying.

When possible, dryers should be installed on an exterior wall to minimize the length of dryer duct leading outdoors. Every foot of dryer vent, and every bend in the vent, reduces the amount of air that passes through the dryer, and increases drying time and expense.

Smooth aluminum dryer vent pipe saves considerable energy over flexible plastic tubing. Smooth vent pipe has far less airflow resistance and results in faster and more economical drying.

Old-fashioned timer controls run the dryer for as long as customers sets them, even if the clothes are dry before the cycle is finished. The new automatic temperature or humidity-sensing dryer controls shut the dryer off as soon as clothes are dry. This saves 10 to 15 percent of the cost of running a dryer and prolongs the life of clothing.

Reducing Laundry Energy Costs

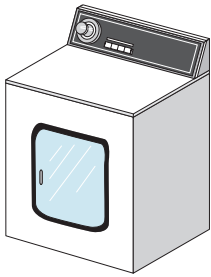

Front-Loading Washer

Front-loading clothes washers are more expensive to purchase than top-loading machines. But if customers usually wash with warm or hot water, these models provide an excellent energy savings.

Somewhere in the middle of a dryer's "automatic" range is a setting that dries clothes without wasting energy by over-drying them.

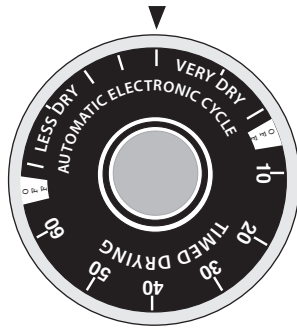

Dryer Control

Save Money by Using a Clothesline

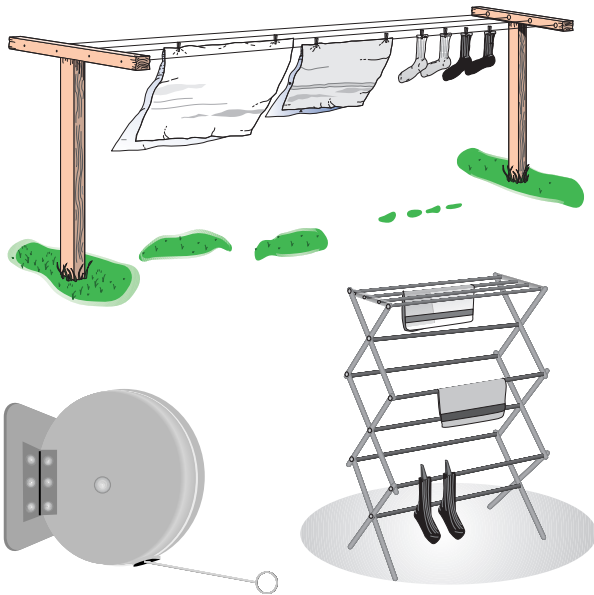

A clothes line is one of the best energy saving devices around. Customers can save a hundred or more dollars a year by drying clothes during dry weather on a clothes line, clothes rack, or a space-saving retractable line.

Recommendations for Customers Using Appliances Efficiently

- ✓ Measure your refrigerator temperature and set at 35 to 40 degrees F. Measure your freezer temperature and set it to 0 to 5 degrees F.
- ✓ Run your dishwasher with full loads only.
- ✓ Set your washing machine to use warm or cool wash and rinse temperatures. Run your washer and dryer with full loads only.
- ✓ Clean your dryer's lint filter after each cycle. Use the electronic or automatic cycle instead of the timer. Consider drying clothes completely on a clothesline, or at least until they are almost dry, finishing in the dryer. They will have the tumbled texture of dryer clothes with less than half the energy use.
- ✓ Evaluate the age and energy efficiency of your refrigerator, dishwasher, and washing machine. Consider appliance replacements with ENERGY STAR labeled appliances.

IMPROVING LIGHTING EFFICIENCY

The average family dedicates up one-fifth of their electrical use to lighting. Fortunately, lighting retrofits are among the easiest energy conservation measures to perform. This is another energy conservation measure that you, the auditor, can perform or help your customer to perform.

Common incandescent light bulbs use 90 percent of their energy producing heat and only 10 percent producing light, making them the most inefficient energy-using device in our homes.

Compact Fluorescent Lights

Compact fluorescent lights (CFLs) use one-quarter to one-third the energy of incandescent lights. They last up to ten times longer than incandescent bulbs and they screw into a standard light socket.

CFLs should be used in the light fixtures that you use the most. Start by replacing incandescent lights that are on four hours a day or more, such as those in the kitchen, bathroom and living room.

Standard CFLs are slightly larger than incandescent light bulbs and may not fit all fixtures. But the smallest compact fluorescent lights, called sub-compact fluorescents, are nearly the same size as incandescent light bulbs.

If you plan to replace an entire light fixture, or are choosing fixtures for a new home, select fixtures that are designed for CFLs. Dedicated CFL fixtures have pin-based replaceable CFL bulbs rather than screw-in bases like standard bulbs. They also include improved reflectors that distribute light more evenly.

Recommendations for Customers Improving Lighting Efficiency

- ✓ Buy and install compact fluorescent bulbs in any fixtures you use more than one hour per day. Replace the most used lamps first. Choose a wattage of one-third to one-quarter the size of the incandescent bulb it will replace.
- ✓ Purchase dedicated CFL fixtures when you next buy light fixtures.

Compact Fluorescent Lamps

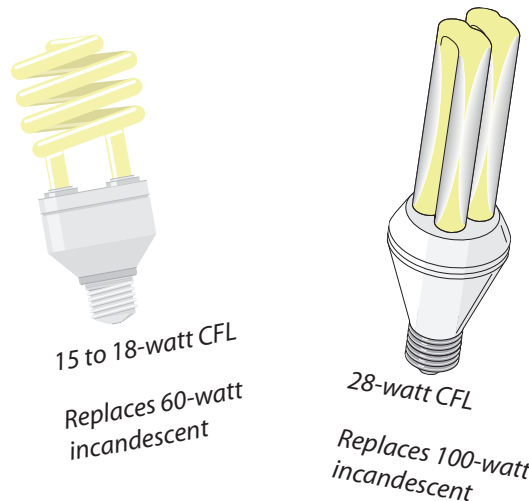

Replacing standard bulbs with compact fluorescent lamps is easy, and savings begin immediately.

HEATING AND COOLING SYSTEMS

EVALUATING HEATING SYSTEMS

Combustion heating systems consume natural gas, propane, or oil to heat homes. Heat pumps utilize the same principles as air conditioners, but include a reversible cycle that allows them to provide both heating and cooling.

Both combustion furnaces and heat pumps include a large fan mounted in a metal box, called an air handler, to move air through duct and out of registers. Supply ducts carry air from the air handler to living space, and return ducts bring room air back to the air handler.

Furnace Service

Gas furnaces should be serviced periodically to ensure that they operate safely and efficiently. Customers can perform some of the most important maintenance tasks themselves.

Furnaces and water heaters that burn oil or gas release combustion gases such as carbon dioxide, water vapor, and carbon monoxide. When the system operates properly, these gases are carried out of the home through a chimney.

Furnace safety and furnace efficiency are closely related to one another. Professional heating technicians perform the essential service tasks such as cleaning the combustion chamber and blower, testing combustion efficiency, and assessing chimney draft. Gas furnaces should be professionally serviced every two to three years.

Furnace efficiency suffers when too little air flows through the ducts. Dirty filters, a dirty blower, damaged ducts, or blocked registers can cause reduced airflow. Another very common cause of low airflow is inadequately sized return air ducts.

Building Science Combustion Heat Transfer

A conventional furnace heat exchanger absorbs heat from the flame's radiation and convection of combustion gases. Home air, moved by the blower, removes the heat from the heat exchanger and delivers it to the home.

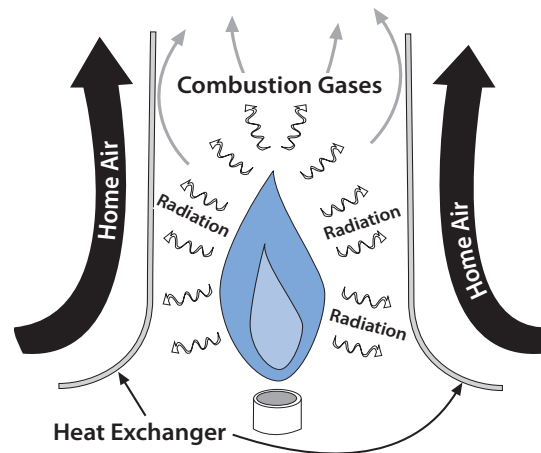

High efficiency furnaces have condensing heat exchangers, in addition to conventional heat exchanger, which pre-heat return air from the home. The incoming return air cools the combustion gases to around 100°F forcing the water vapor in the gases to condense and to liberate significant additional heat.

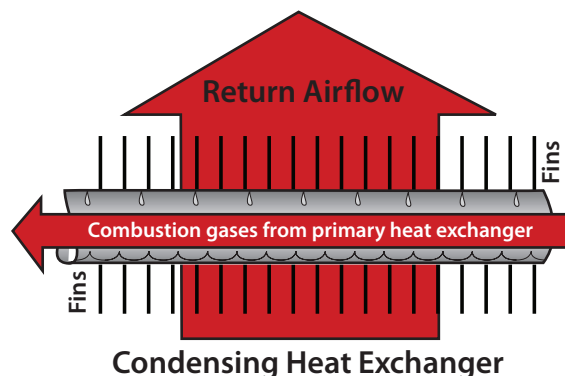

Condensate from the combustion gases is drained into a floor drain or sewer.

Duct blockage has two major effects. The first is to reduce airflow through the ducts, which reduces heating efficiency. The second is increased air leakage through the building shell due to house pressures that are created by the blockage. Both of these waste energy. A heating technician should evaluate the airflow through ducts to confirm that it is balanced among all the rooms in the house. Some furnaces are so starved for return air that the customer may need to add an additional return grill and ducts to get adequate airflow.

Furnace Replacement

Furnace efficiency is rated by Annual Fuel Utilization Efficiency (AFUE), which must be posted on a furnace's Energy Guide Label. The Energy Guide Label is a federal requirement for many types of energy-using appliances. See "ENERGY STAR® and Energy Guide Labels" on page 9.

If a furnace has no draft fan and an old-fashioned pilot light, the customer should consider replacing it. This type of open-combustion furnace usually operates at an AFUE of 65 to 75 percent. Customers have two efficiency choices when shopping for a new gas furnace.

1. An improved version of older existing furnaces that has an AFUE of up to 82 percent. This furnace is equipped with electronic ignition and a draft fan. We call this choice the 80+ furnace.
2. A condensing furnace that has an AFUE greater than 90 percent. This condensing furnace recovers extra heat from combustion gases by extracting water from the combustion gases with a special corrosion-resistant heat exchanger. We call this choice the 90+ furnace.

An 80+ furnace saves between 10 and 15 percent compared to an older furnace, and a 90+ furnace saves between 20 and 25 percent. When estimating how much a new furnace can reduce a customer's heating bills, look at the portion of their calculated winter heating cost. See "Analyzing Energy Consumption" on page 4.

Comparing 80%+ and 90%+ Furnaces

Existing chimneys may need to be re-lined to accommodate a smaller and more efficient furnace

80+ Furnace with Re-Lined Chimney

Condensing furnaces vent through an exterior wall or out the roof.

90+ Furnace with Plastic Vent and Air Intake

90+ furnaces have sealed combustion, with combustion air coming from outdoors to reduce backdrafting concerns

Condensing heat exchanger cools gases and removes water to reclaim more energy

Considering the cost difference between the two furnace options, the 90+ furnace is by far the better option. These more advanced furnaces are safer in addition to being more efficient than the 80+ option.

If a new 80+ furnace is vented into an existing masonry chimney, the chimney may need to be upgraded at the same time. Many existing furnaces are oversized, so the existing chimney is often too large for a new correctly-sized 80+ furnace. The upgrade usually involves re-lining the chimney with a new metal liner.

The 90+ furnace avoids the chimney issue since it usually employs new PVC plastic pipe for venting combustion gases. The plastic vent can exit the home either through a sidewall or the roof. Combustion air is drawn from outdoors through a second dedicated plastic pipe. This venting system provides superior health-and-safety benefits when compared to furnaces that vent into vertical chimneys and draw their combustion air from indoors.

Installing a new plastic-piped vent for a 90+ furnace sometimes leaves a gas water heater venting into an existing chimney that was originally sized to accommodate both a furnace and a water heater. The old chimney may be too large for the “orphaned” water heater, resulting in poor chimney draft, condensation, and mortar deterioration. The usual solution is to install a smaller chimney liner or an entirely new chimney that is sized for the water heater alone.

Replacing Furnace Filters

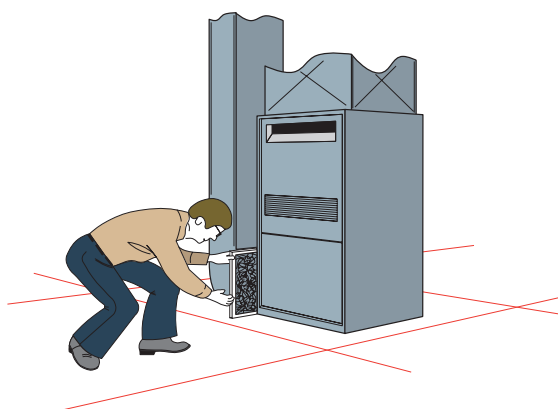

Learn where your furnace filter or filters are located, and clean or replace them when they get dirty. The filter shown here is located in the furnace's return plenum. Some filters are located behind a return air grille in the living space.

Balancing a Furnace's Airflow

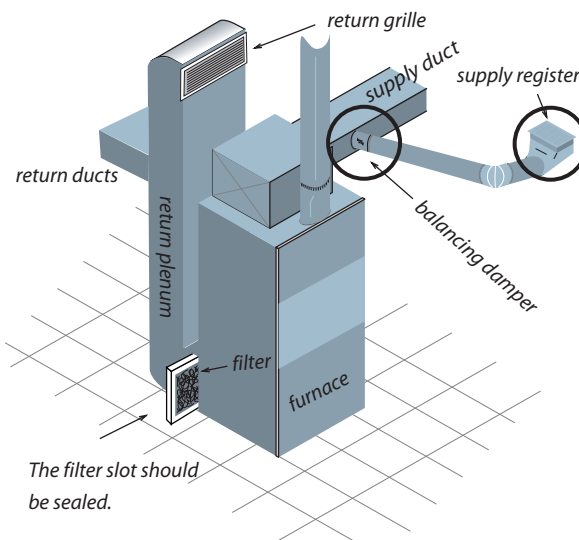

A furnace should move equal amounts of air to and from of home's living spaces. A heating contractor can adjust the supply air by using either the balancing dampers in the ducts or the adjustable dampers in the supply registers.

Recommendations to Customers Improving Heating System

Customer Tasks

- ✓ Inspect the filter in your furnace or heat pump. Clean or change it if it's dirty.
- ✓ Install a carbon monoxide detector.

Professional Service

- ✓ Clean the furnace's combustion chamber and blower compartment.
- ✓ Perform a carbon monoxide test, and confirm that the chimney removes combustion gases from the home under all conditions.
- ✓ Test the combustion efficiency, and adjust as needed.
- ✓ Confirm that the furnace filter completely fills the opening where it is installed. Install a sealed cover over the filter slot to prevent air leakage.
- ✓ Verify the airflow by measurement with a duct blower or other method, and upgrade the duct system as needed.
- ✓ Measure the duct leakage with a duct blower or other method, and seal the duct leaks as needed.
- ✓ Balance the airflow to the supply registers using balancing dampers.

Heating System Replacement

- ✓ Select a furnace with an ENERGY STAR label. This new furnace should have an efficiency rating (AFUE) of greater than 90 percent, and it should have a sealed combustion chamber.
- ✓ Be sure the furnace is sized correctly to the house heating load. This sizing should account for any improvements made to the building shell, which may mean that it has a smaller capacity than the old one.
- ✓ Confirm that the chimney is sized correctly for the new system. Upgrade the chimney if needed.

EVALUATING COOLING SYSTEMS

Cooling systems include central air conditioners, room air conditioners, and evaporative coolers.

Central Air Conditioning

Central air conditioners are the largest electrical appliance in many homes. Without regular service, air conditioner's efficiency can fall by as much as 50 percent. Proper maintenance and repair saves energy and money, while extending the life of air conditioning equipment.

Customers can perform a few simple maintenance tasks. However for the majority of maintenance tasks, the customer should hire an air-conditioning professional who has specialized tools and training.

The filter in a furnace or air conditioner protects the blower, heat exchanger, and cooling coils from dirt. If these components get dirty, they are difficult and expensive to clean. Changing or cleaning filters helps protect the fans and heat-exchange surfaces.

Filters should be changed or cleaned every few months. The most common filters are made of a fiberglass mat mounted in a cardboard frame. These are disposable, and customers can buy them from home improvement stores. Other filters are made of washable plastic fibers.

Building Science Latent Heat and Cooling

Latent heat is the heat released when a vapor condenses to a liquid or the heat absorbed when a liquid boils into a vapor.

Sweating, air conditioning and evaporative cooling all use the principle of latent heat.



Sweat evaporating from the skin carries a lot of heat away from the body. Sweat evaporates rapidly in dry air and slowly in humid air.

Evaporative coolers reduce the temperature of dry outdoor air by making that air evaporate water. Evaporative coolers only work in dry climates, because adding moisture to already humid air would be uncomfortable. Humid air suppresses the evaporation of sweat.

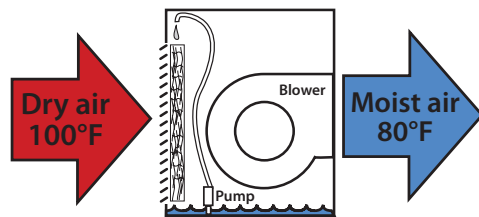

Air conditioners use a refrigerant to move heat from the home to the outdoors. When the refrigerant evaporates in the evaporator, heat is removed from the air by the evaporation. When the refrigerant condenses again in the condenser, the heat is absorbed by the outdoor air flowing through the condenser.

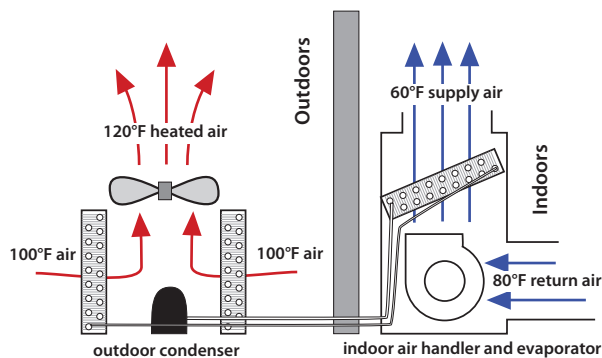

Simple Service for Central Air Conditioners

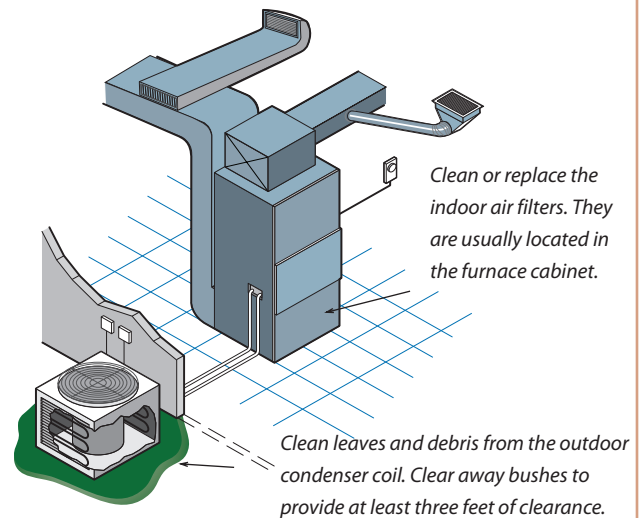

Many central air conditioners employ a "split system" design, with a condenser coil and compressor installed outdoors and an evaporator coil installed indoors.

Duct Efficiency

Poor performance of both cooling and heating systems is often the result of poor duct design and installation. These performance and energy problems result from the following conditions.

- Air leakage through holes in ducts.
- Heat loss through the walls of ducts.
- Inadequate airflow through ducts.

In many homes, duct leakage wastes 15 to 25 percent of the energy consumed by the heating and cooling systems. Contractors can perform a duct air-tightness test that measures and locates duct leakage.

Duct leaks near the air handler are the most important to seal because the air pressure is greatest in ducts nearest to the blower. It's particularly important for a contractor or homeowner to seal all air leaks in the return air ducts near the furnace. These draw air in from their surroundings, and can cause a furnace or water heater to backdraft and spill combustion gases into the living space.

This potential backdraft problem is one good reason to have ducts sealed by a professional, who has measuring equipment to test for possible safety problems.

If a customer chooses to seal their duct systems, they should not use standard gray fabric duct tape, since its adhesive tends to fail quickly. Duct mastic, available in buckets and painted over duct seams, is the preferred sealant.

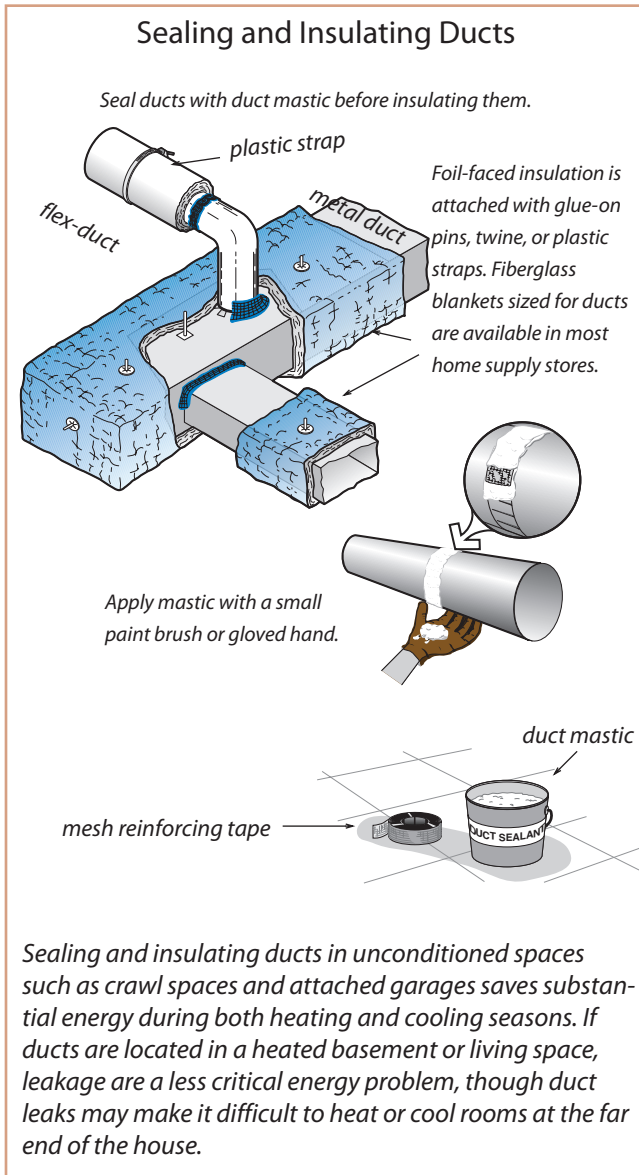

Recommendations for Customers Servicing Cooling System

Customer Tasks

- ✓ Before doing any service work, shut the unit off at its main switch.
- ✓ Clean or replace the filter located inside the metal air handler cabinet or behind a return air register. This may be the same filter that serves the furnace.
- ✓ Remove plants and other debris from within 3 feet of the outdoor unit. Make sure the upward path of air leaving the unit is unrestricted for at least 5 feet.

Professional Service

- ✓ Clean the blower so that it moves air more efficiently.
- ✓ Balance airflow to each room to provide consistent comfort.
- ✓ Verify the airflow by measurement with a duct blower or other method, and upgrade the duct system as needed.
- ✓ Measure the duct leakage with a duct blower or other method, and seal the duct leaks as needed.
- ✓ Clean the indoor evaporator and outdoor condenser coil. If there is no access panel, install one.
- ✓ Check the refrigerant charge and adjust if needed.
- ✓ Straighten any bent fins on the condenser and evaporator coils.

Room Air Conditioners

Portable room air conditioners are typically located in a window and cool one room. Cleaning a portable air conditioner's filter and coils helps the portable unit perform well and minimize electricity use.

Room air conditioners contain filters that protect their indoor cooling coils from dust and debris. The filter is behind a removable louvered cover on

the room side of the unit. You or the customer can remove this cover and the foam filter and wash both in the kitchen sink with soap and water.

The condenser coil is accessible from the outdoor side of the room air conditioner. The outdoor coil is similar to the indoor coil, though more difficult to clean.

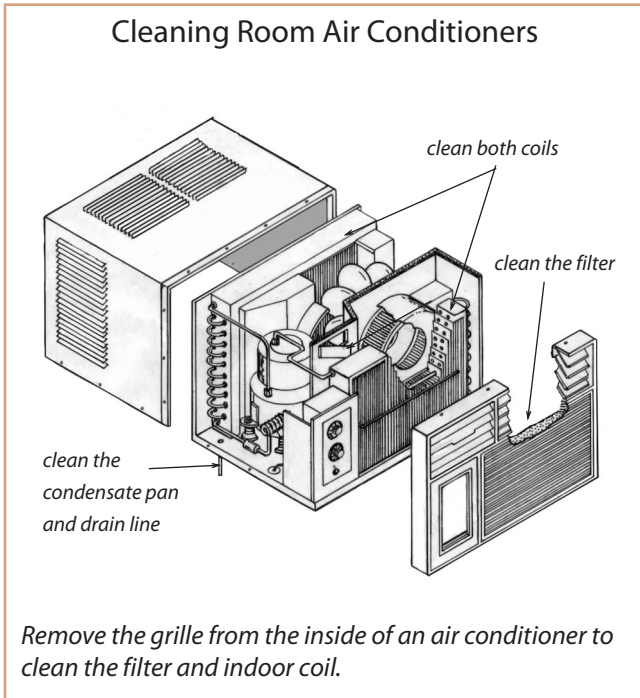

Building Science Solar Radiation

The sun's arc through the sky changes with the season. In winter the sun scribes a low arc, staying in the southern sky all day. At the equinoxes, the sun rises higher, and the summer sun rises highest and stays in the sky for the longest of any season.

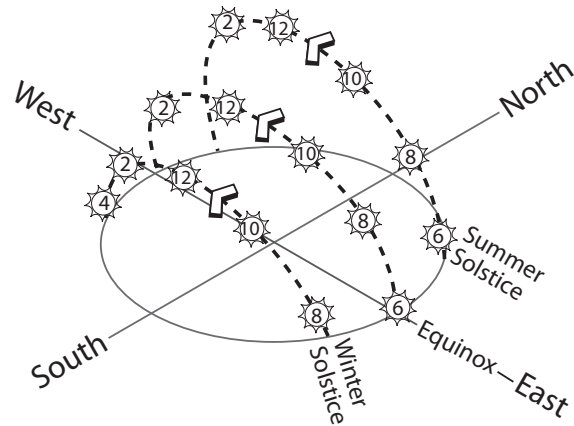

Glass in a greenhouse transmits solar radiation, which heats objects in the greenhouse. The warm objects emit infrared radiation (IR), which is absorbed by the glass. The glass then emits IR back to the greenhouse and out into space.

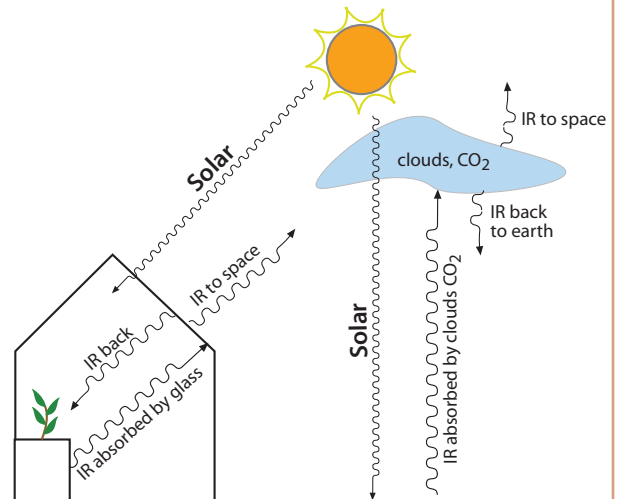

The earth's atmosphere transmits solar radiation, which heats the earth. The earth emits IR out towards space. Some of the IR escapes the atmosphere and some is trapped by clouds and CO₂. The trapping of heat by materials in the atmosphere is called the "greenhouse effect".

Evaporative Coolers

Evaporative coolers (also called swamp coolers) are a highly efficient alternative to air conditioners. They are a popular and energy-efficient cooling strategy in the dry climates of the western U.S.

Unlike central air conditioning systems, evaporative coolers provide a steady stream of fresh air to the home. This can be a problem if the home is located in a dusty or polluted environment, but for many homeowners the fresh air is a benefit.

Evaporative cooler fans move air through absorbent pads that are saturated with water. The absorbent pads are made of aspen wood fibers, glass fibers, or specially formulated cardboard. Some of that water evaporates, reducing the temperature of the hot outdoor air. As this cooler air is forced into the house by the fan, it pushes warmer air out through open windows or out through dedicated vents in the ceiling or walls.

A water pump in the reservoir pushes water through tubes into a drip trough, which then drips water onto the pads. A float valve connected to the home's water supply keeps the reservoir supplied with fresh water to replace the evaporated water. The reservoir is flushed periodically to remove debris, and the drain water can be directed to nearby landscaping.

Evaporative coolers operate much more cheaply than air conditioners. They do not have a SEER rating, but if they did, it would be between SEER 30 and 40, or 2 to 3 times the SEER of the most efficient air conditioners. Recent studies show that the typical savings from using evaporative cooling rather than air-conditioning is 3000 to 4000 kilowatt-hours of electricity per year, or \$450 to \$600 at current rates.

Unlike air conditioners, evaporative coolers do consume water. But the cost of this additional water is minimal when compared to the electrical savings, accounting for only \$10 to \$20 in increased annual water costs for most homeowners. The issue of water consumption for evapora-

tive coolers is even less of an issue when viewed on a regional basis, since most of the electrical generating plants that support air conditioners consume vast quantities of water themselves.

Traditional Evaporative Cooler

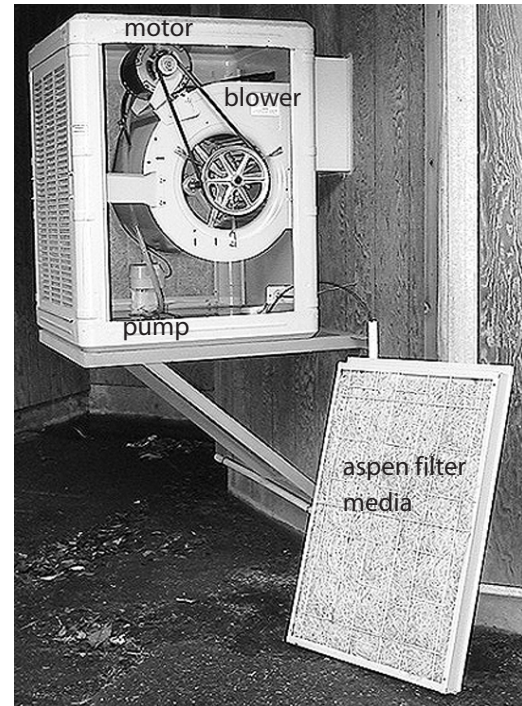

Traditional steel coolers need faithful maintenance to provide good service. Their installed cost is \$800 to \$1500, making them an extremely good investment in hot and dry climates.

Evaporative Cooler Maintenance

Most problems with evaporative coolers are caused by neglecting basic maintenance. The more it runs, the more maintenance it needs. An evaporative cooler will definitely need a major cleaning every season, and may need routine maintenance several times during the cooling season. In very hot climates where the cooler operates much of the time, the customer may need to look at the pads, filters, reservoir, and pump every few weeks. It is a small price to pay, considering that the monthly cost of running an evaporative cooler may be hundreds of dollars less than running an air conditioner.

THERMOSTATS

A thermostat is an automatic on-off switch for a furnace or air conditioner. The thermostat's temperature settings determine how much fuel or electricity the customer uses for heating and cooling.

During the heating season, when the home's temperature drops *below* the chosen temperature setting, the thermostat activates the furnace. After the temperature rises to the desired level, the thermostat turns the furnace off. During the cooling season, the thermostat activates the cooling system when the temperature in the home rises *above* the setpoint.

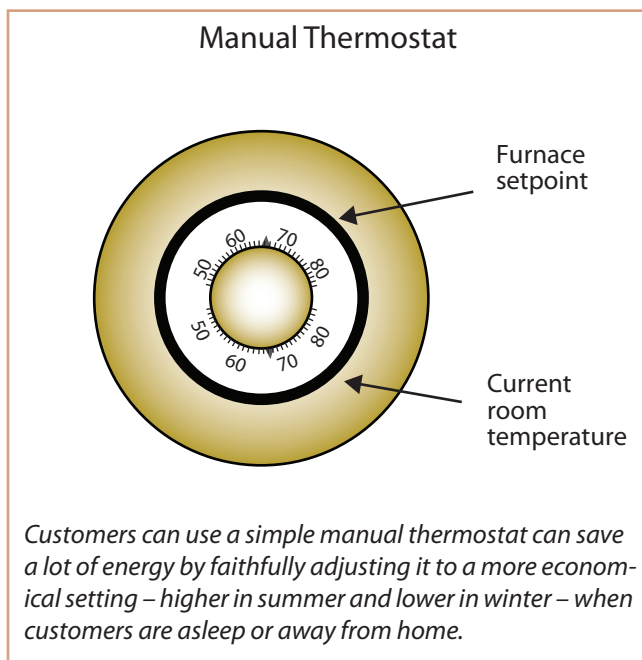

Thermostat Management

During the winter, most people can be comfortable at a thermostat setting of 68 degrees or less. Wearing warmer clothing helps customers stay comfortable at energy-conserving indoor temperatures. During the summer, customers with air conditioning should be comfortable at a thermostat setting of 78 degrees or higher. Wearing light clothing in the summer helps customers stay comfortable at higher indoor temperatures.

Customers can save energy by turning their thermostat to a more economical temperature when they are sleeping or away from home. In the winter, advise customers to adjust their thermostat down 5 to 15 degrees when they go to bed or leave for work. In the summer, customers can adjust the thermostat up 5 to 15 degrees when they're away from home and can use nighttime ventilation instead of air conditioning.

A thermostat isn't like the gas pedal of a car: setting it higher or lower than needed won't speed up a heating or cooling system's response. Advise customers to avoid wasting energy when they return home or get up in the morning by setting their thermostat to the desired temperature and then leaving it alone.

Programmable Thermostats

Programmable thermostats adjust themselves automatically to save energy when customers are sleeping or away from home. Programmable thermostats are one of the most reliable energy savers available, and if used properly they can provide savings of 10 to 15 percent on heating and cooling costs. If the customer already sets back their thermostat regularly then the savings may be minimal. However if the customer has difficulty controlling their existing thermostat then installing a programmable thermostat could be a good energy savings option.

Programmable thermostats are most convenient and effective for families who have regular schedules. The heating and cooling system must be capable of changing the home's temperature quickly too. Many massive buildings don't allow a rapid temperature change and so aren't good candidates for programmable thermostats.

Most programmable thermostats have the capacity to set back the temperature twice daily and also to allow separate schedules for weekdays and weekends. Families who are gone at work or at school

save the most because they can schedule two daily setback periods, saving energy for more hours per day.

Some customers don't want automatic temperature adjustment or can't use programmable thermostats because of the technological challenge they present. Customers can achieve similar savings by faithfully operating their manual thermostat.

Advise customers to set the temperature lower at night, before going to bed, to minimize the time that the heating systems runs while customers are asleep. Customers raise the temperature back to a daytime setting when they get up in the morning, then set it back again if everyone in the family is gone for the day.

allow less heated areas to become too cold during the heating season. This can cause condensation in those areas leading to mold and mildew problems.

Space heaters and room air conditioners are more efficient than central heating and cooling systems because they don't have ducts. Ducts typically waste around 25 percent of the heating and cooling energy through air leakage and heat transmission.

If customers have difficulty paying energy bills during cold or hot weather, then changing to zone heating or cooling from whole-house heating or cooling can save up to 50 percent of energy costs.

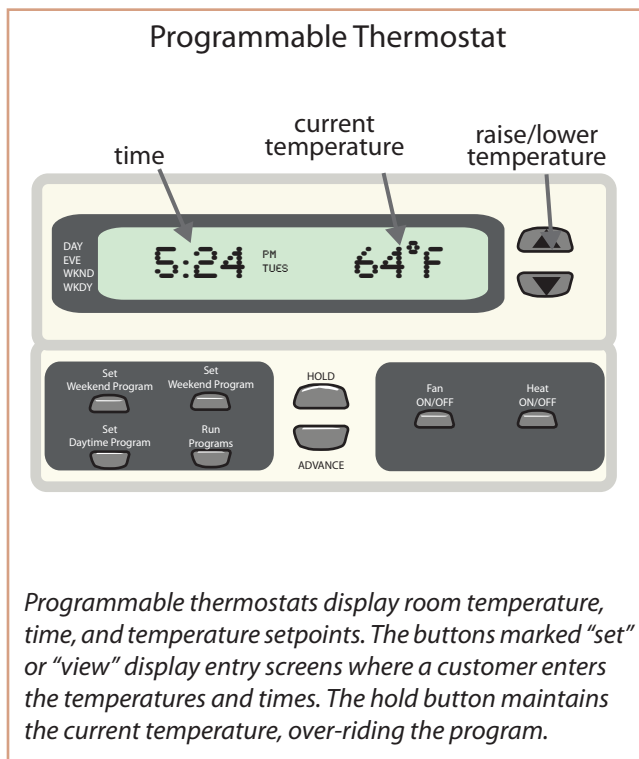

Zone Heating and Cooling

Zone heating and cooling is a strategy for saving energy by only heating or cooling part of the home to a comfortable temperature. The remainder of the home is heated or cooled to a less comfortable temperature or not at all. Care must be taken not to

Building Science Human Comfort

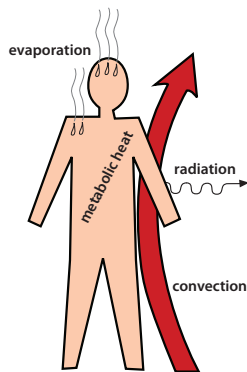

The human body must lose heat on a constant basis to maintain the required body temperature. The body prefers to lose this heat through convection and radiation. When convection and radiation are adequate, you don't sweat. Sweat and its evaporation happens when high temperatures, strenuous activity, or excessive clothing cause body temperature to rise.

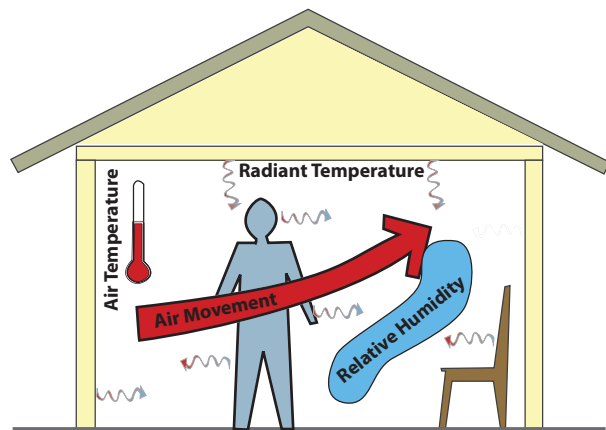

Radiant temperature is the average temperature of surfaces in the home. Indoor air temperature and radiant temperature are the most important factors determining comfort. Air movement has a chilling effect, beneficial in summer and problematic in winter. High relative humidity suppresses the evaporation of sweat, problematic in summer and unimportant in winter.

PASSIVE COOLING MEASURES

Customers can reduce their air conditioning bills or avoid using air conditioners by improving their home's thermal efficiency. Most passive cooling methods cost far less in the long run than air conditioning.

Passive cooling can take the place of air conditioning. And when customers do use air conditioning during the hottest weather, passive cooling measures still reduce electrical use.

Exterior shading is the most efficient way to prevent solar energy from over-heating a home. Trees offer the best window and roof shading, if they are located correctly, and trees add value to a home.

Landscaping Reduces Solar Heat Gain

Plant tall leaf-bearing trees 10 to 15 feet away from the south-facing side of the home to block solar heat from high in the summer sky.

Plant wide trees 15 to 30 feet away from the home's west side to block low-angle solar heat during hot summer afternoons.

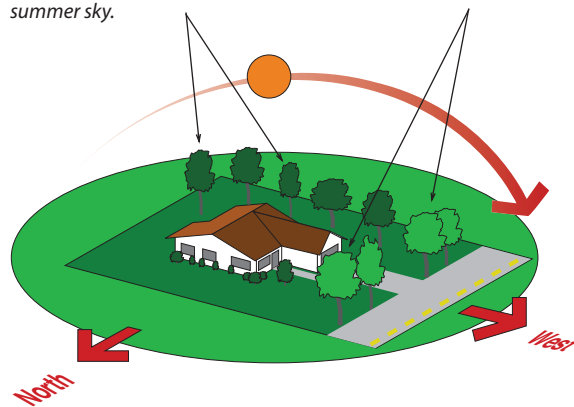

Mature trees provide the best shading of all methods. Trees should block summer sun while allowing winter sun to warm the home.

Sun screens can help reduce the amount of solar heat entering windows. Sun screens are built like insect screens, but with a shading fabric that blocks about 70 percent of the solar heat before it enters the window. Sun screens work particularly well for

un-shaded windows facing west or east. Most glass shops can make and install sunscreens at a reasonable price.

Reflective roofs reduce attic temperatures, and so reduce the flow of heat down through ceilings. Customers planning to re-roof their homes should consider installing a white-colored reflective roof.

Customers can use fans in two different ways to cool their homes and reduce cooling costs. The first is to create a wind-chill using room circulating fans in occupied rooms. Studies show that people feel an average of 4 degrees cooler when the air around them is moving. The second method is to move heat out of the home during the evening and night using window fans or a whole-house fan. The cool night air will flush out the heat the home collected during the hot summer day. This works best in areas where the night temperatures are at least 15 degrees cooler than during the day.

Customers can also minimize the heat produced inside their homes by installing efficient appliances and lights. When these appliances minimize energy use, they also minimize heat production. See *“Using Appliances Efficiently”* on page 8.

Recommendations for Customers Passive Cooling Measures

- ✓ Plant trees on the south side of a home to shade the windows and roof.
- ✓ Install sun screens or awnings on east and west windows.
- ✓ Use circulating fans to create a wind-chill effect in occupied rooms. Turn the fans off when rooms are unoccupied.
- ✓ Use ventilating fans to move hot air out of a home at night. Turn the fans off in the morning and close the windows and curtains to help keep the home cool as the outdoor temperature rises.
- ✓ Buy efficient appliances that have an ENERGY STAR rating to reduce internal gains.

BUILDING SHELL

EVALUATING INSULATION

Insulation is the most important element in making a home comfortable and energy-efficient. Attic and wall insulation are the best energy investments for many homes.

Insulation is rated by R-value, which measures thermal resistance. Each type of insulation has a particular R-value for each inch of thickness. The International Energy Conservation Code (IECC) requires that new homes have R-values of at least R-38 in attics, R-19 in walls, R-13 in basement walls, and R-30 in floors above crawl spaces.

Insulation Types and Choices

Fiberglass batts are the most common insulation found in existing homes. Many homes have fiberglass batts in both wall cavities and attics.

Loose-fill insulation can also be blown into walls. The blown blanket has no voids or edge gaps, if installed properly, and is usually more thermally resistant than fiberglass batts. Blowing insulation comes in two common varieties: fiberglass and cellulose. Both fiberglass and cellulose settle after they are installed. Cellulose settles 15 to 20 percent and fiberglass settles 3 to 5 percent. Settling isn't much of a problem in attics as long as a customer plans for it by adding more insulation in the first place.

Plastic foam insulation, like polystyrene and polyurethane, is available in 4-foot by 8-foot or 2-foot by 8-foot sheets of various thicknesses. Plastic foam insulation is a moisture and air barrier, unlike fibrous insulation. Foam sheets can be used to insulate masonry walls or to insulate the interior or exterior of frame walls.

by professional crews with truck-mounted equipment although spray foam is also available in small

Building Science How Insulation Works

Insulation traps air within fibers or plastic cells. The small air pockets contain still air. Heat must conduct through the still air, which is a slow process compared to conducting through a solid material or traveling by convection or radiation.

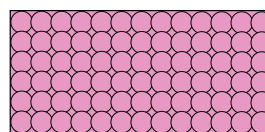

foam insulation

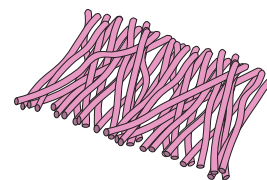

fibrous insulation

Heat convects and radiates through an empty wall cavity, which is a rapid process compared to heat traveling through insulation.

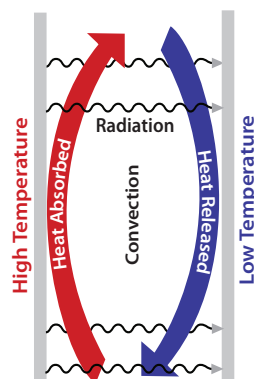

Heat convects and radiates across an empty

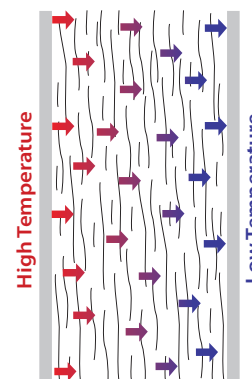

Heat conducts through the air pockets, trapped

Sprayed polyurethane foam is sometimes used to insulate walls, foundations, or roofs. This sprayed foam is costly to install, but worth its higher price when adhesion, moisture-resistance, air-sealing ability, and structural strength are important. Sprayed polyurethane insulation is usually applied and large containers.

Retrofit Attic Insulation

Loose-fill insulation is blown into attics using an insulation-blowing machine. It is inexpensive and easy to install. If your customer's ceiling has less than 6 inches of insulation (about R-25), adding insulation to a total of 14 to 16 inches (or about R-49) is an excellent investment.

Many lumber yards and rental businesses rent small insulation-blowing machines to their customers. If a customer is handy and doesn't mind getting dirty, he or she can install the insulation.

Advise customers to seal air leaks in the attic are sealed before installing attic insulation.

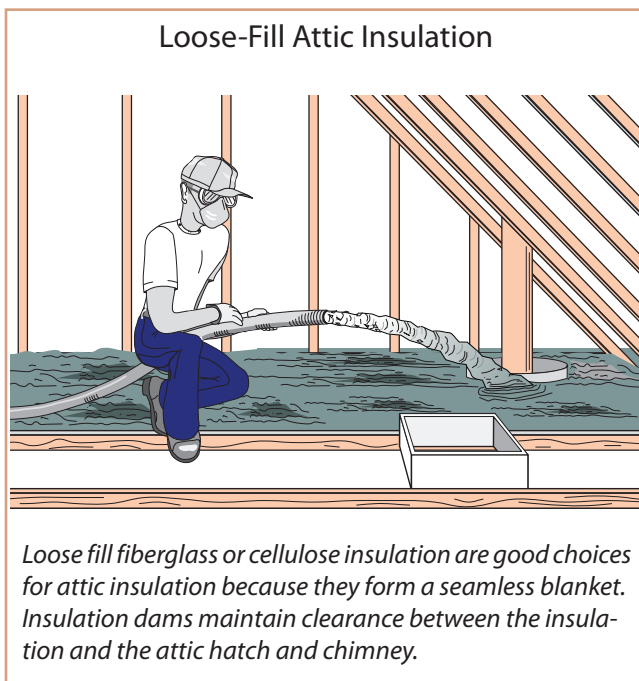

Retrofit Wall Insulation

Many older homes were built with little or no wall insulation. Since a home's wall cavities are out of sight, it's hard to know how much insulation they contain. But if a customer's home is more than 30 years old, it's worth the effort to find out. One of the best ways is to remove the cover plate of an electrical outlet (be sure to turn the power off first). Use a flashlight to peer around the electrical box into the wall cavity. Another trick is to drill an

inspection hole in an inconspicuous place such as a closet. The wall cavity should be completely filled with insulation.

Wall insulation is usually blown into the wall cavities of existing homes through holes in the interior or exterior wall surfaces of the exterior walls. Loose-fill insulation should be installed at sufficient density to avoid settling. The best insulation contractors ensure high density throughout the wall by blowing insulation through a tube that is inserted into the wall cavity, rather than through a nozzle that merely penetrates the cavity.

Customers planning to install new siding or to paint the interior or exterior have a good opportunity to blow insulation into uninsulated or partially insulated wall cavities at the same time. During painting or siding replacement, customers can reduce or even eliminate the cost of patching the holes need to install cavity insulation.

Insulating foam sheets can also be attached to walls if the old siding is removed and before a home is re-sided, adding valuable extra thermal resistance.

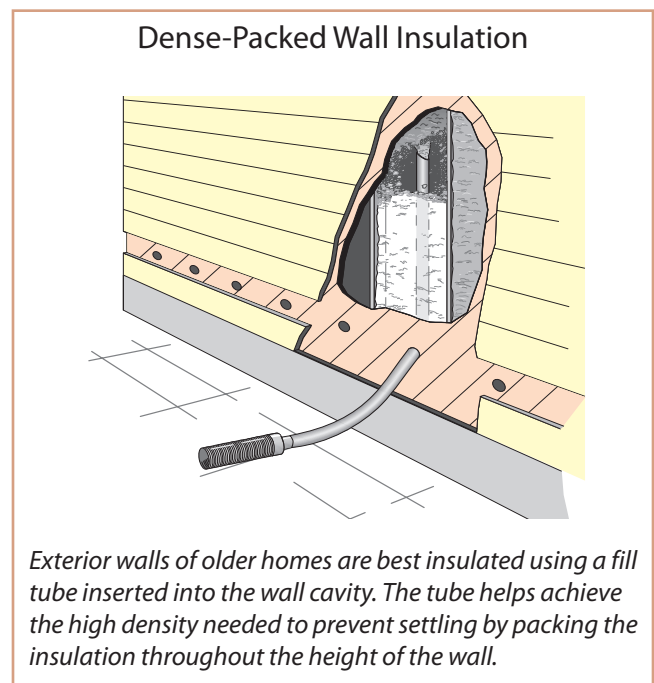

Retrofit Crawl-Space Insulation

When homes are built over crawl spaces, they should be insulated at either the floor above the crawl space or at the foundation walls around the crawl space. Many existing homes have no insulation in the floor or crawl space walls, resulting in a high percentage of the total heat loss occurring in and around the crawl space.

If the customer decides to insulate the floor above the crawl space, the insulation contractor should fill the floor cavity or insulate to at least R-30. This can be achieved with a 9¹/₂-inch un-faced fiberglass batt or blown fiberglass insulation. Fiberglass-batt floor insulation must have permanent support such as wood strips or wires. The insulation must be in continuous contact with the underside of the floor to be effective. Avoid the use of faced batts for floor insulation since faced batts tend to trap moisture.

Homeowners may also choose to insulate crawl space walls with foam insulation or fiberglass batts.

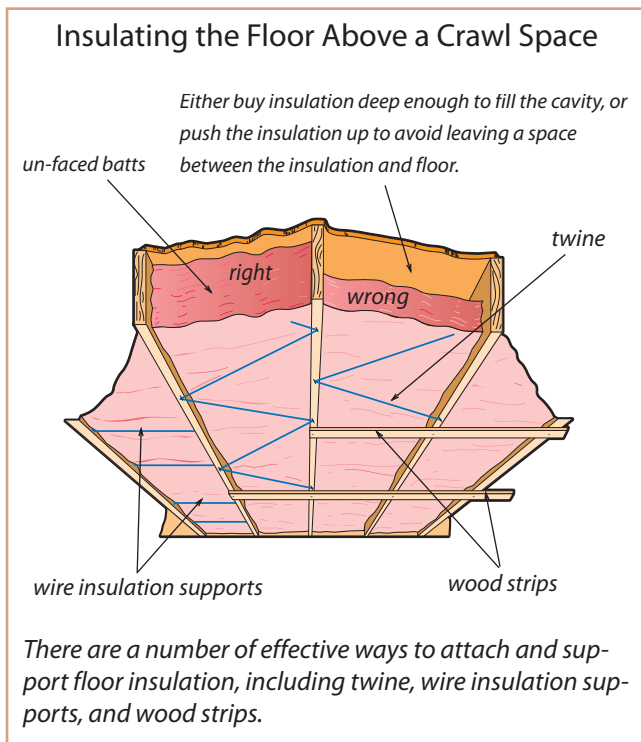

Crawl Space and Basement Insulation

Standard Basement Insulation

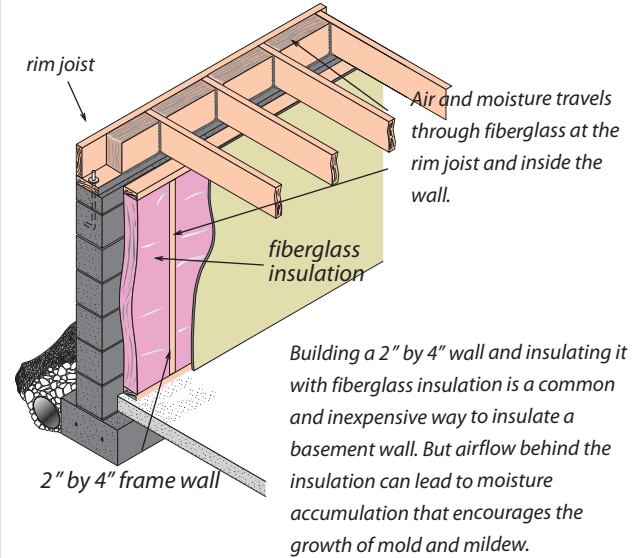

Improved Interior Insulation

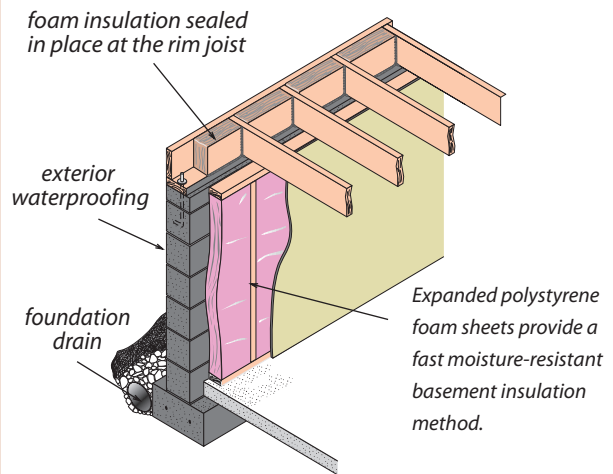

Exterior Basement Insulation

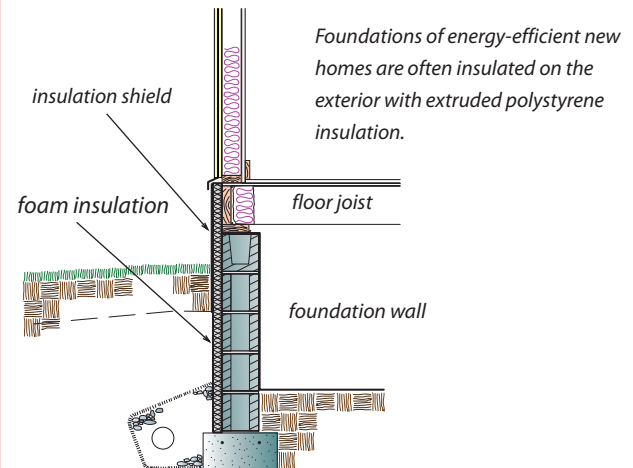

With either floor insulation or foundation insulation, the contractor must control moisture in the crawl space by installing a ground moisture barrier. Polyethylene sheeting makes a good ground moisture barrier over the bare soil. The contractor should seal the polyethylene's edges and seams with an appropriate sealant.

Moisture problems should be solved first, before insulating the floor cavity or foundation walls of a crawl space. If moisture accumulates in the crawl space or elsewhere in the home, it encourages the growth of mold, mildew, or rot. Insulation should never be installed in a wet crawl space. See *“Evaluating Moisture in Homes”* on page 34.

Foundation Insulation

When a house has a heated basement, the basement walls are usually insulated and the floor above the basement isn't insulated. The most common way to insulate basement walls is to build a framed wall against the foundation and fill it with fiberglass batts. The frame is then covered with drywall and, sometimes, a plastic vapor barrier. The vapor barrier creates a moisture trap, however, because moisture finds a path into the wall where it becomes trapped. Moisture accumulation in the wall encourages the growth of mold, mildew, and rot.

A better choice for basement wall insulation is polystyrene foam, installed in sheets that are either 2 or more inches thick. If installed at the exterior, as would be during new construction, use durable water-resistant insulation, such as blue or pink extruded polystyrene. The exposed foam needs protection from damage above ground level. Sheet metal, fiberglass panels, or troweled-on stucco can protect the foam installation. If foam board is installed at the interior, as is typical for retrofit applications, the foam must be covered with drywall to provide a fire barrier and a finished surface.

Whether a contractor insulates the floor or foundation wall, he or she should insulate the rim joist at the same time. Although fiberglass is most com-

monly used, foam insulation, or a combination of foam insulation and fiberglass, is better because moisture sometimes migrates behind the fiberglass and condenses on the cold rim joist, causing damage from mold or rot. Spraying polyurethane foam in the rim-joist area and even in the framed wall is very effective for both insulating and air-sealing.

Installing floor insulation slightly increases the probability of pipe freezing during very cold weather. The most common pipe-freezing locations are in crawl spaces where pipes travel near the foundation wall and especially near basement windows. Insulating the pipes or wrapping them with self-regulating heat tape may be necessary to prevent freezing in cold climates.

Insulating Values of Construction Materials	
Material	R-value per inch
Concrete	0.1
Wood	1.0
Fiberglass insulation, loose-fill or blown	2.8–4.0 ¹
Cellulose insulation	3.0–4.0 ²
Vermiculite insulation	2.2
Expanded polystyrene foamboard (white, known as beadboard)	3.9–4.3 ¹
Extruded polystyrene foamboard (usually blue, yellow, or pink)	5.0
Polyurethane or polyisocyanurate foam (spray application)	5.5–6.5 ³

1. Varies according to density.
 2. Varies according to density and quality.
 3. Varies according to age and formulation.

SEALING AIR LEAKS

Air leaks in the walls, ceilings, and floors can waste up to 30 percent of the energy consumed by home heating and cooling equipment. Holes and gaps in a home's shell also allow moisture, insects, dust, and pollutants to enter the home. Sealing air leaks reduces this energy loss and also keeps airborne moisture from entering building cavities, where it could encourage the growth of mold, mildew and rot.

Sealing Air Leaks in the Attic

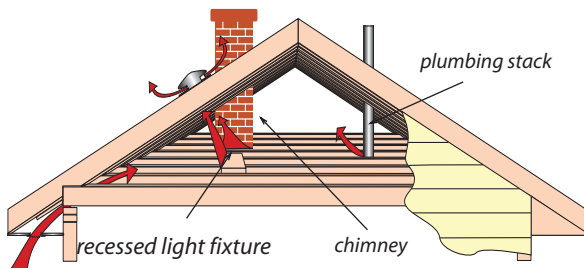

Attics harbor a variety of air leaks that draw conditioned air out of homes. These should be sealed before installing attic insulation to slow heat loss and prevent moisture damage.

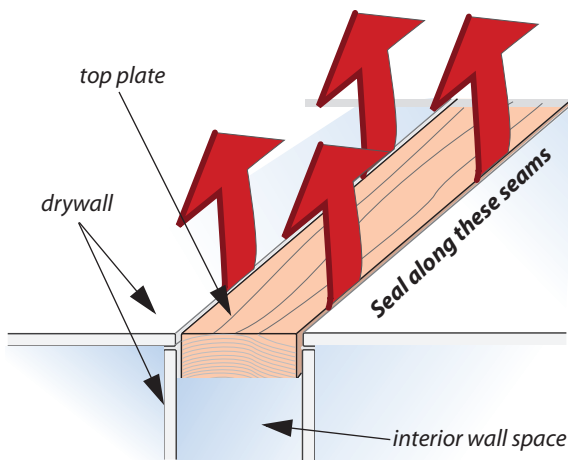

Air can enter interior walls and attics by passing around outlets, beneath the baseboard, and through other holes and cracks. The air then passes easily through the fibrous attic insulation. Contractors should seal the tops of these wall partitions and other gaps in the ceiling, using caulking or spray foam, before installing attic insulation.

The best way to find air leaks is by performing a blower door test. This analysis is often used by contractors who perform whole-house energy retrofits. A blower door test can also yield important information about whether mechanical ventilation is needed to protect a home's indoor air quality.

The air leakage sites that result in the greatest energy loss often include these locations.

- Recessed light fixtures.
- Penetrations from chimneys, pipes, wires, and electrical boxes through floors and ceilings.
- The perimeter of the floor framing (called the rim or box joist).
- Junctions of exterior walls and floors.
- Junctions of exterior walls and the roof or ceiling.
- Gaps between structural framing and door or window frames.
- Leaks into attic through top plates of interior walls.
- Outlets and switches in exterior walls.

The smallest air leaks can be sealed with caulking. Moderate size openings are best sealed with one-part canned foam sealants that expand in place. Two-part foams, which are packed in a pair of canisters and furnished with an applicator nozzle, can fill larger gaps. Seal the largest openings, as around plumbing chases in the attic or crawl space, with plywood or rigid-foam insulation.

Door and window weatherstripping may improve comfort by reducing drafts in the living space. But the reduction in air leakage, achieved with weatherstripping, is a small part of the overall air leakage of a typical home.

Contractors should locate and seal air leaks in the attic or floor before installing attic or floor insulation. Fibrous insulation, like fiberglass and cellulose, is not an air barrier when loosely installed in attics. However, densely packed insulation, installed in walls, reduces air leakage because it plugs small cracks and resists airflow in wall cavities.

Building Science House Air Pressures

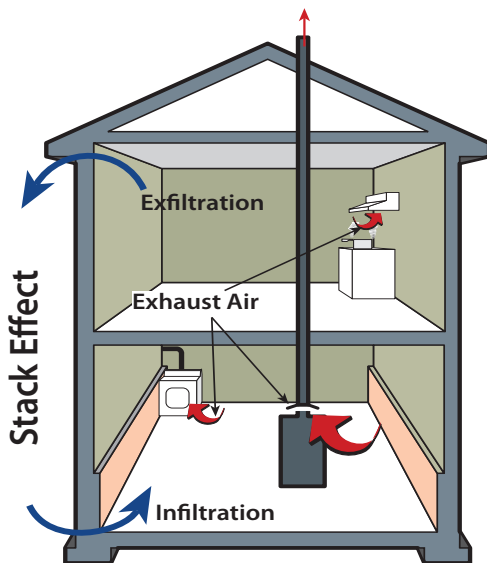

The buoyancy of warm air creates the “stack effect” in tall homes. The stack effect causes air to enter low (infiltration) and leave high (exfiltration) through the home’s air leaks. Exhaust fans, clothes dryers, and chimneys create negative pressure in the home because they remove air from the home.

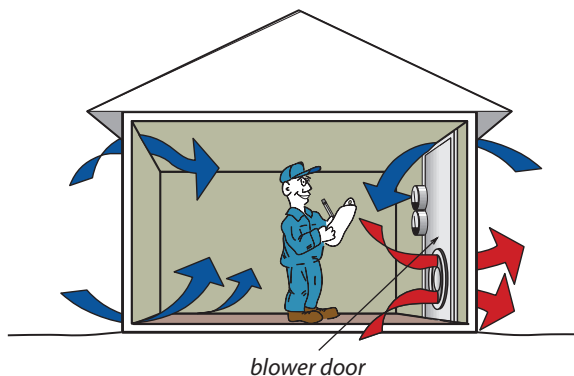

A blower door applies a strong negative pressure to the home to measure the home’s air leakage. A blower door can also help to find large air leaks.

Air Leakage and Ventilation

Some air exchange between the house and the outdoors is essential to remove excess moisture, carbon dioxide, and other pollutants. But excess air leakage results in uncomfortable drafts, and increases heating and cooling costs.

Fresh air enters the home from either unintentional air leakage or through a whole-house ventilation system. Most homes are ventilated by air leakage, but more efficient homes with airtight shells need fan-powered whole-house ventilation systems.

Unintentional air leakage provides fresh air and dilutes pollutants. However, air leakage is unreliable, over-ventilating a home during cold windy weather and under-ventilating the home during mild calm weather. Exhaust fans aid natural ventilation (air leakage) by removing pollutants at their source—in bathrooms and kitchens.

Every kitchen and bathroom should have an exhaust fan that is ducted to the outdoors. Ducting fans into an attic or crawl space causes moisture damage. Clothes dryers must always be vented outdoors, too, because their exhaust contains moisture, lint, and chemicals from fabrics and soap. Moisture itself isn’t a pollutant, but excessive moisture encourages the growth of mold, mildew, and rot.

Ask your customers how their homes feel during cold weather. If a home is drafty and excessively dry, leading to static-electricity shocks, then excessive air leakage is probably the cause. If a home is moist with condensation collecting on windows, and cooking odors lingering, then this home may be tight. Blower-door testing is the best way to actually measure airtightness.

Tight houses may lack an adequate air supply for combustion appliances, like furnaces and water heaters. Too little combustion air can lead furnaces to produce carbon monoxide and cause chimneys

to backdraft. The heating technician performs should test to confirm that heating appliances receive sufficient air to operate properly.

Back-Drafting Caused By Depressurization

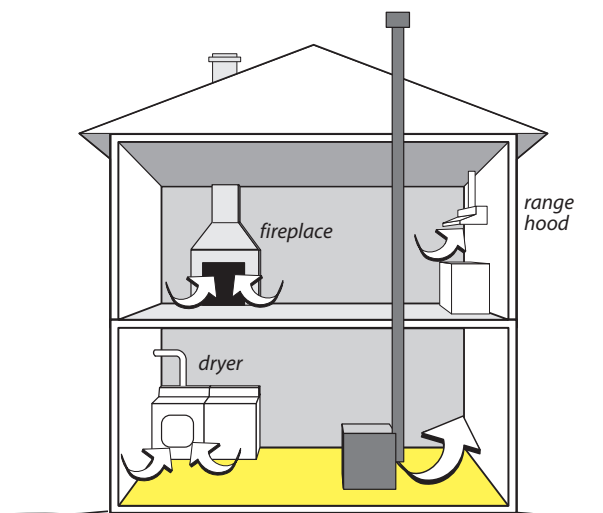

Appliances that exhaust air—such as dryers, fireplaces, and exhaust fans—create a suction that can cause furnace and water heater chimneys to backdraft and possibly spill carbon monoxide into the home. Sealed combustion appliances are not subject to this problem.

EVALUATING WINDOWS

Windows are usually the weak link in the home's thermal barrier. Windows must provide two important benefits: light and a view. That's why even the best windows have an R-value of R-2 to R-3, while the wall they are installed in may have an R-value of R-8 to R-20.

Unfortunately, it is difficult to justify the expense of buying new windows because the cost is so great and it takes so many years to pay off in energy savings. Customers should consider replacing windows only after they have performed all the more cost-effective energy improvements.

Storm Windows

Storm windows are often more cost-effective than window replacement. Storm windows can be installed on either the inside or outside of the home.

A storm window adds a layer of glass to slow heat loss, reduce energy costs, and increase comfort. Storm windows generally cost \$8 to \$15 per square foot including installation.

The most familiar type of storm windows have aluminum frames and sashes. Exterior aluminum storm windows remain a good energy improvement for windows with single or even double-pane glass. They permanently mount to the exterior of a wood double-hung window. These storm windows should have sliding mechanisms and built-in insect screens for summer ventilation.

The sliding sashes of an exterior storm window should be removable from the inside to allow easy cleaning and access for fire escape. A little silicon lubricant, sprayed in the track occasionally, helps the sashes slide freely.

Primary window sashes can sometimes be fitted with a fixed exterior or interior storm window for less cost than a sliding storm window. Non-movable storm windows can be clipped or permanently attached to existing window frames or sashes. Customers can order high-efficiency low-e glass for these immovable storm panels. Low-e (low emissivity) glass slows the heat that is *emitted* from the glass. In this case, the low-e surface should face the space between the glass panes to protect the fragile coated-glass surface.

Installing new, inexpensive sliding windows on the *interior* of existing horizontal or vertical sliding windows is also an option for existing metal windows that are in good condition.

Interior storm windows with plastic frames and plastic glazing aren't as permanent as metal-and-glass storm windows. However, they are usually more airtight than metal storm windows. The air-

tight seal of indoor storm windows is created by closed cell foam tape, Velcro®, or magnetic tape. The glazing material is usually clear plastic, which loses transparency with exposure to ultraviolet sunlight over the years. In some temporary applications, plastic film is applied directly to the window frame.

Building Science How Summer Heat Accumulates

Summer heat accumulates inside homes in hot weather by solar radiation, air leakage, internal gains, and the indoor-outdoor temperature difference.

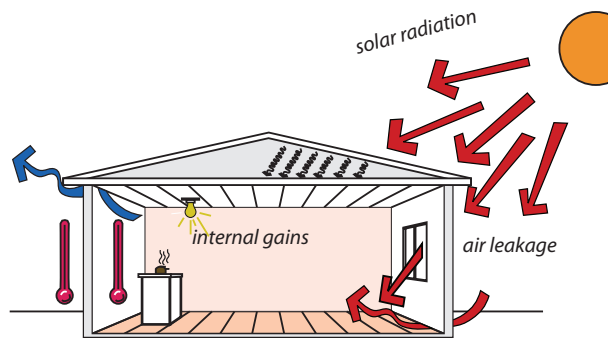

Every home has different percentages of heat gain coming from the four sources. Differences in a home's shading, air-tightness, indoor heat generation, and insulation level cause these percentage differences.

Component	Low	High
Solar Gains – Windows	15%	35%
Solar Gains – Roof	10%	30%
Solar Gains – Walls	3%	8%
Internal Gains – Heat	10%	25%
Internal Gains – Humidity	5%	15%
Air Leakage – Heat	10%	20%
Air Leakage – Humidity	5%	25%
ΔT Indoor-Outdoor	4%	12%

Building Science Windows, Energy and Comfort

The cold window glass creates convection currents that feel drafty. Heat radiates from people and other warm objects indoors toward the glass. Air leaks through the cracks around the window.

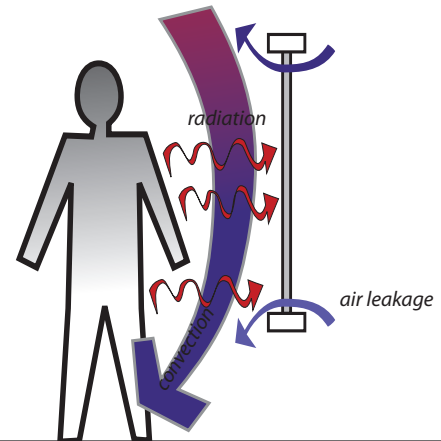

An insulated glass unit consists of two panes of glass sealed together and separated by a spacer. One of the panes is often coated by a thin layer of metal, called a low-e coating. Low-e coatings reduce the flow of heat radiation through the IGU.

Choose low-e glass

Choose Argon-gas filling between the panes

Choose a warm-edge spacer

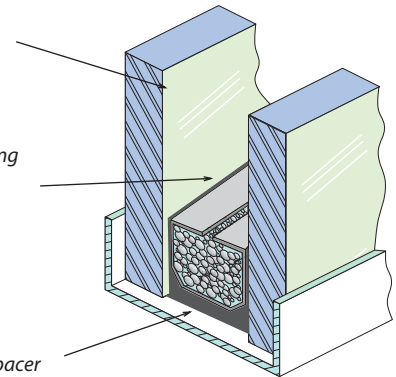

The low-e coating can also regulate solar energy. The coating can have a high solar transmittance for solar heating or a low solar transmittance to block solar heat to reduce air conditioning and improve summer comfort.

Window Condensation

Water may condense on windows during cold weather. This is normal during the coldest weather, but if windows fog up or ice up frequently, this wetness can damage the windows, the window sills, or the walls under the windows. Two factors affect how much condensation occurs on windows:

- The amount of humidity in the home. Greater humidity causes more condensation on windows.
- The thermal resistance of windows. Windows with a low R-value is colder in the winter, causing condensation to form.

Reducing the sources of moisture inside a home reduces a home's humidity. See "Evaluating Moisture in Homes" on page 34. Increasing the thermal resistance of windows reduces the chances of window condensation. Customers should consider installing storm windows or new primary windows to increase thermal resistance. If a home's indoor humidity is too high, installing new windows or storm windows may not solve window-condensation problems. There is no substitute for reducing sources of moisture in the home.

New Windows

Replacement windows commonly cost between \$30 to \$70 per square foot of window area, installed. Vinyl and aluminum-clad wood windows dominate the window market. Vinyl window frames have good thermal resistance, low cost, and no maintenance. However vinyl windows are generally less durable than aluminum-clad wood windows. Aluminum-clad wood windows have excellent life span and low maintenance but are significantly more expensive than vinyl.

Though the thermal resistance of insulation is measured in R-value, the thermal resistance of windows is measured in U-factor. A low U-factor means that heat travels slowly through the window. This reduces the cost of home heating in the winter, though it is also a slight benefit during the cooling season. Buy windows with a U-factor of U-

0.40 or less for greater winter comfort and lower heating bills. A lower U-factor will also reduce moisture condensation on the glass during cold weather. Single-pane glass has a U-factor of about 1.10, while energy-efficient double- and triple-pane windows have U-factors of between 0.20 to 0.35.

A low Solar Heat Gain Coefficient (SHGC) is desirable for east and west facing windows. A low SHGC reduces solar heat gain during hot summer weather, which can limit or eliminate the need for air conditioning. Windows with a SHGC of 0.40 or even 0.30 are recommended to reduce summer over-heating.

Window Rating Labels

Technical Information				
Res	U-Factor	.32	Solar Heat Gain Coefficient	.45
			Visible Transmittance	.58
			Air Leakage	.3
Non-Res		.31		.45
				.60
				.3

Manufacturer stipulates that these ratings conform to applicable NFRC procedures for determining whole product energy performance. NFRC ratings are determined for a fixed set of environmental conditions and specific product sizes.

Observe the top row only; the bottom row includes commercial ratings.

The most energy-efficient windows will have an ENERGY STAR logo on the NFRC label, usually in the upper right corner. A low U-Factor (good resistance to heat flow) is important in a cold climate where heating is the primary energy use. A low SHGC (solar heat gain coefficient) is important in a warm climate where cooling costs are high.

Windows with a U-factor of 0.35 or better (lower numbers) include several advanced features.

- Double-pane or triple-pane insulated glass units. Some manufacturers use plastic films as the interior pane in triple-pane windows.

- Low-e coating on one of the panes. This is a thin metallic coating that reduces heat emission between the panes.
- Argon gas between the panes instead of air. Argon is less conductive than air, and is subject to less thermal convection than plain air.
- Warm edge spacers. These conduct less heat through the edges of insulated glass units, improving comfort and reducing condensation on the edges of the glass and frame.

Many customers are tempted to buy new windows without thinking about whether the purchase is cost-effective. Remind customers that window replacement usually has a payback of 20 years or more, making it one of the last energy conservation priorities discussed in this training manual.

Recommendations for Customers Improving Windows

- ✓ If customers have single-pane windows, storm windows are an inexpensive upgrade that save energy, improve comfort, and protect the primary window from the elements.
- ✓ Before replacing existing windows, invest in insulation, appliances, lighting, and energy-efficient heating and cooling systems. These improvements that usually have a better return on investment than windows.
- ✓ If customers decide to replace windows, they should spend the extra money to buy premium windows that bear the ENERGY STAR label.

Thermal Properties of Insulated Glass Units

Glass Type	U-Factor	R-Value
Single-pane clear glass	1.1	0.9
Insulated glass unit (IGU) clear glass, 1/2" space	0.5	2.0
Low-e IGU with 1/4" space	0.44	2.3
Low-e IGU with 1/4" space and Argon gas filling	0.38	2.6
Low-e IGU with 1/2" space	0.33	3.0
Low-e IGU with 1/2" space and Argon gas filling	0.29	3.4
Triple-pane low-e on two surfaces	0.20	5.0

EVALUATING MOISTURE IN HOMES

Too much moisture in a home can reduce its durability and comfort. Though some moisture is normal in every home, excess moisture can accumulate and damage a home's structure. It can also encourage the growth of mold, mildew, and other organisms, which can cause health problems like allergies and asthma. If you notice musty odors in a customer's home, or if you see dark stains on walls and ceiling, you should help your customer investigate the cause of moisture accumulation.

Leakage through the roof, around doors and windows, or from plumbing leaks can allow a great deal of moisture into a home. Fixing these leaks is the first defense against moisture problems.

Homes with dirt-floored crawl spaces often absorb a lot of moisture from the ground. A ground-moisture barrier, such as plastic sheeting, should be installed in these homes to prevent water vapor from migrating into the home. If you find standing water in a basement or crawl space, advise the customer to consider installing a sump pump to carry water away. A customer's gutters and downspouts, should direct water away from the home. Customers should also limit irrigation around their foundations if they have moisture problems.

Most homes need ventilation to remove moisture and odors that come from bathing, cooking, and other activities. Bathrooms and kitchens should have operating ventilation fans that are vented to the outdoors.

The earth around a home is another potential source of moisture. Though some home sites are inherently wet and moisture control can be difficult, many sources of moisture are easy to correct.

Building Science Moisture Control

Excess moisture can deteriorate buildings and make residents sick because of biological airborne particles.

Excess moisture can encourage the growth of mold, mildew, and rot.

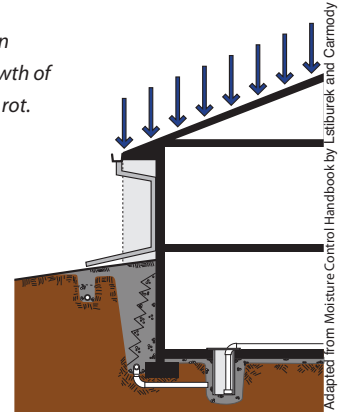

The most important place to control moisture is in the ground around and beneath the home's foundation. Water should drain away from the home. Water that invades the ground around the foundation should be able to drain away

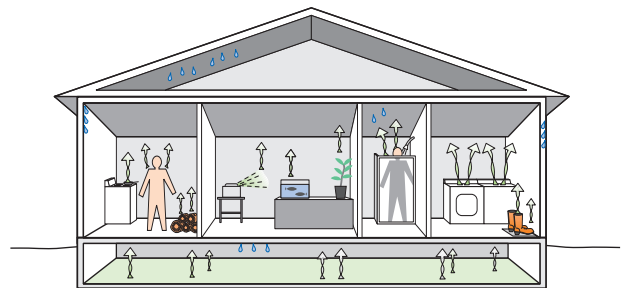

Moisture sources inside the home can lead to condensation in the home and in building cavities like the attic and crawl space. The condensed water can damage metal and masonry and provide sustenance to pests, which eat cellulose and produce airborne allergens.

Recommendations for Customers Controlling Moisture in Homes

- ✓ Protect your home from ground moisture by installing a ground moisture barrier, sloping the ground away from your foundation, and installing gutters and downspouts if needed.
- ✓ Protect your home from exterior moisture by repairing any leaks in your roof or siding.
- ✓ Install ducting for your dryer that discharges moisture to the outdoors.
- ✓ Reduce sources of indoor moisture and other pollutants by installing and using exhaust fans.

FINDING MORE INFORMATION

Home Performance with ENERGY STAR

Provides standards for improving the efficiency of existing homes, and certifies contractors to perform work that meets these guidelines. Website includes extensive information for both homeowners and professionals.
1-888-STAR-YES (782-7937)
www.energystar.gov

Energy Efficiency and Renewable Energy Network

Connects to the wide range of web-based information available from the Department of Energy.
www.eere.energy.gov

American Council for an Energy Efficient Economy

Publishers of *Consumer Guide to Home Energy Savings* and other building performance guides.
202-429-0063
www.aceee.org/consumerguide

Home Energy Magazine

Publishers of technically oriented bimonthly magazine on energy efficiency. Also produces the excellent book *No Regrets Remodeling*.
510-524-5405
www.homeenergy.org

